

GSA-ST & GSA-HT GUIDED ELECTRIC ROD-STYLE ACTUATORS

ENDURANCE TECHNOLOGYSM
A Tolomatic Design Principle



LINEAR SOLUTIONS MADE EASY





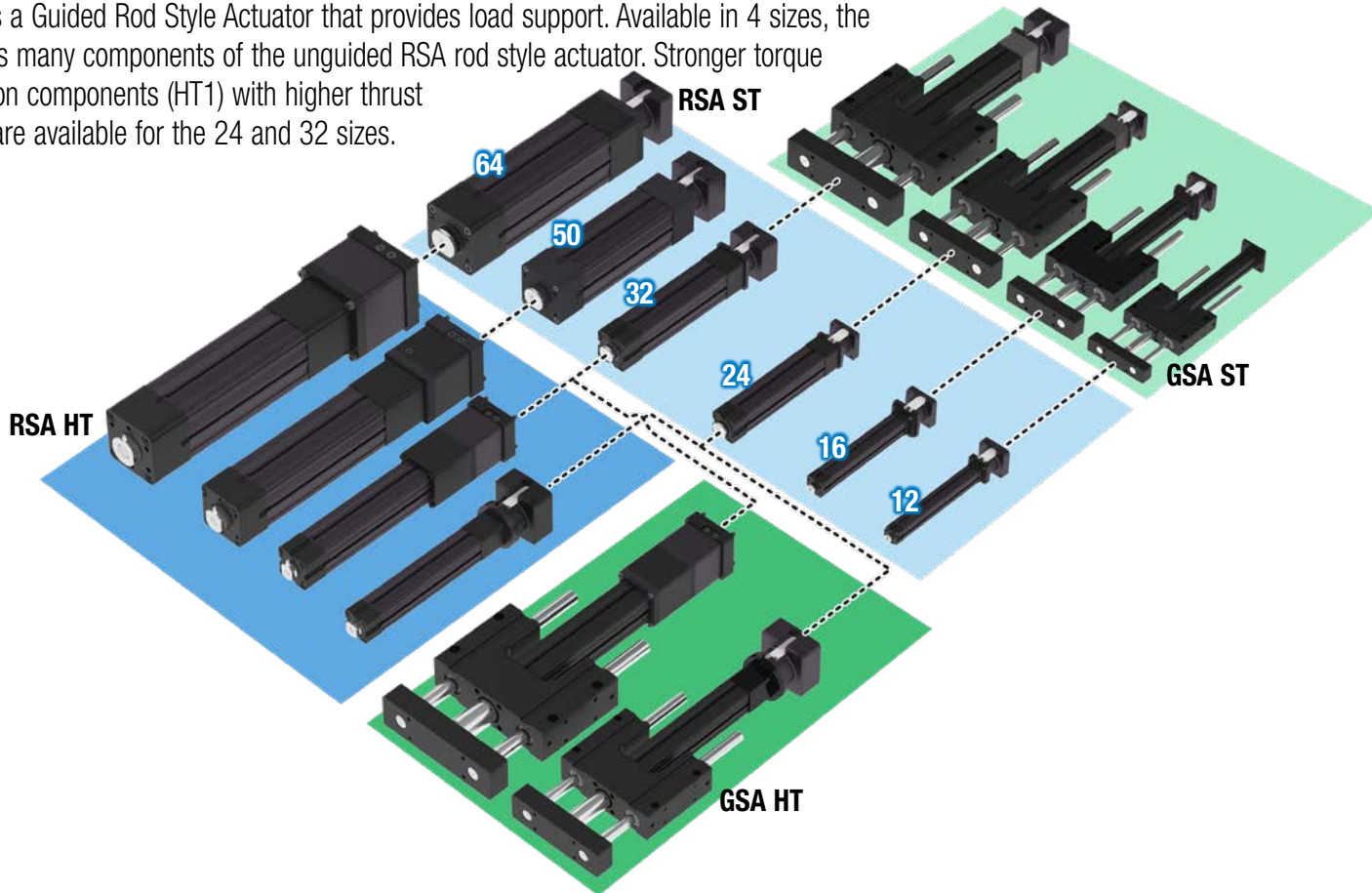

GSA GUIDED SCREW-DRIVE ACTUATOR

WHAT IS THE GSA SERIES?

The GSA is a Guided Rod Style Actuator that provides load support. Available in 4 sizes, the GSA shares many components of the unguided RSA rod style actuator. Stronger torque transmission components (HT1) with higher thrust capability are available for the 24 and 32 sizes.



TOLOMATIC'S ELECTRIC ROD-STYLE ACTUATORS

	ERD	RSH	RSA	RSX	GSA	IMA
						
	Rod-Style Actuator	Hygienic Rod-Style Actuator	Rod-Style Actuator	Rod-Style Actuator	Guided Rod-Style Actuator	Integrated Servo Actuator
Force up to:	2.2 kN (500 lbf)	35 kN (7,943 lbf)	58 kN (13,039 lbf)	294 kN (66,000 lbf)	18.5 kN (12,760 lbf)	35.8 kN (8,044 lbf)
Speed up to:	1,016 mm/sec (40 in/sec)	498 mm/sec (19.6 in/sec)	3,124 mm/sec (123 in/sec)	760 mm/sec (29.9 in/sec)	3,124 mm/sec (123 in/sec)	1,334 mm/sec (52.5 in/sec)
Stroke Length up to:	609 mm (24 in)	1,219 mm (48 in)	1,524 mm (60 in)	1,500 mm (59 in)	914 mm (36 in)	457 mm (18 in)
Screw/Nut Type	Solid & Ball	Ball & Roller	Solid, Ball & Roller	Ball & Roller	Solid & Ball	Ball & Roller
<i>For complete information see www.tolomatic.com or literature number:</i>						
Literature Number:	2190-4000	2100-4010	3600-4233	2171-4001	3600-4231	2700-4000

(Not all models deliver maximum values listed, i.e.: Maximum thrust may not be available with maximum speed)

GSA GUIDED SCREW-DRIVE ACTUATOR

Applications

Gantries and Multi-Axis Applications

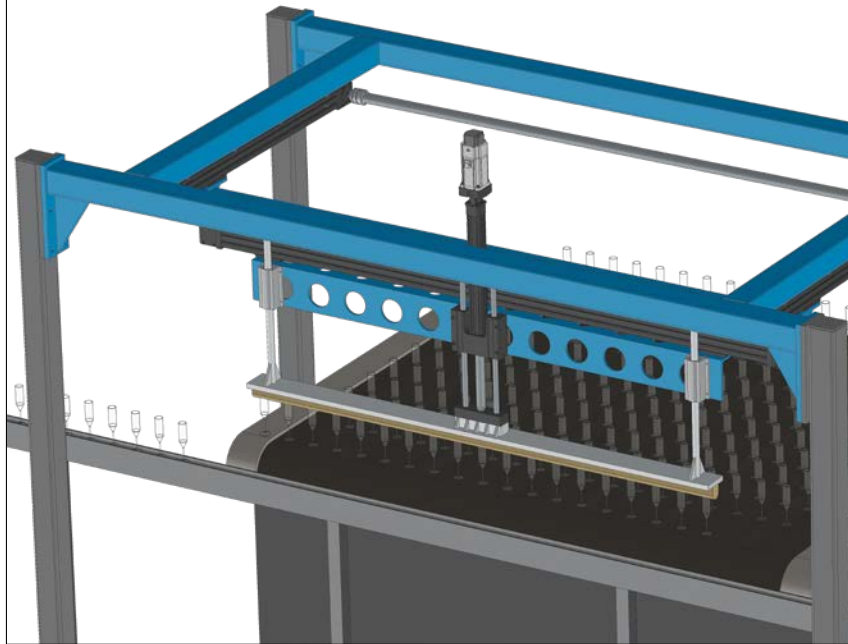

Overhanging Loads

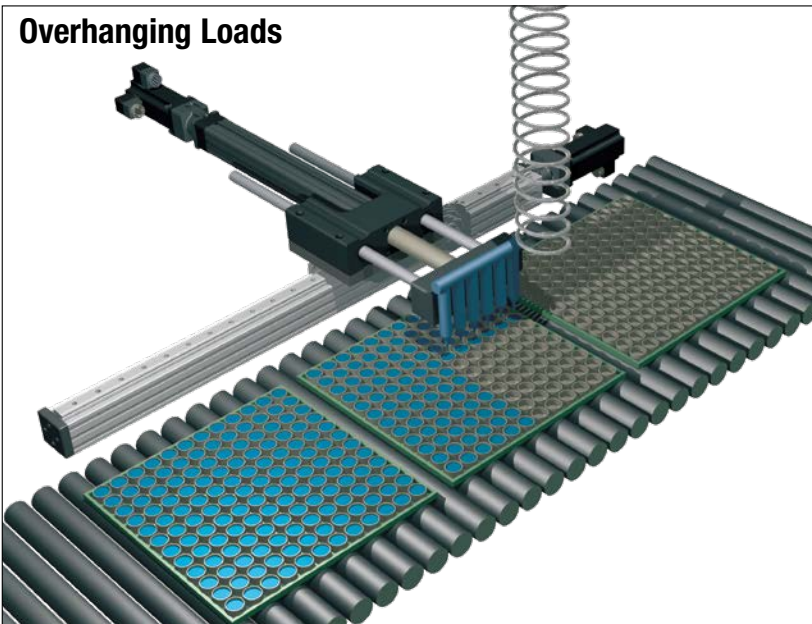

CONTENTS

What is the GSA.....	GSA_2
Applications.....	GSA_3
GSA-ST Features.....	GSA_4
GSA-HT Features.....	GSA_5
Specifications.....	GSA_6
Guide Rod Deflection....	GSA_14
Dimensions.....	GSA_18
Switches.....	GSA_23
Appl. Data Worksheet....	GSA_25
Selection Guidelines.....	GSA_26
Service Parts Ordering....	GSA_27
GSA Ordering.....	GSA_28
Tolomatic Difference.....	GSA_29

Other Applications:

- Animation
- Assembly machinery
- Automatic tool changers
- Automotive
- Clamping
- Converting
- Conveyors
- Cycle testing
- Fillers
- Formers
- Hydraulic replacement
- Laser positioning
- Machine tools
- Material handling
- Medical equipment
- Molding
- Motion simulators
- Open / close doors
- Packaging equipment
- Parts clamping
- Patient lifts
- Pick & place
- Pneumatic replacement
- Precision grinders
- Product test simulations
- Riveting / fastening / joining
- Robot manipulator arms
- Sawmill equipment
- Semiconductor
- Stage motion control
- Stamping
- Table positioning
- Tension control
- Test stands
- Tube bending
- Volumetric pumps
- Water jet control
- Wave generation
- Web guidance
- Welding
- Wire winding
- and many more

GSA-ST GUIDED SCREW-DRIVE ACTATOR

The self contained guided rod design of the GSA makes it a ideal solution for applications requiring compact guidance support of a load, or side load mitigation. The large mounting surface of the tooling plate and guide body allows for a rigid connection between the mounting surface and the load.

The ST option on the GSA (pictured below) is ideal medium force applications.

LIGHTWEIGHT ALUMINUM DESIGN For application flexibility

Black anodized bearing block provides solid structural support and multiple mounting options

Black anodized tube extrusion design is optimized for rigidity and strength

External switch channels on all sides allow easy placement of position indicating switches

ROD WIPER For long life

Prevents contaminants from entering the housing for extended life of the actuator

PRECISION MACHINED SURFACES For mounting flexibility

Extruded bearing housing is precision machined on two surfaces for true and easily aligned linear motion

Tooling plate is aligned and assembled to provide a precise mounting surface

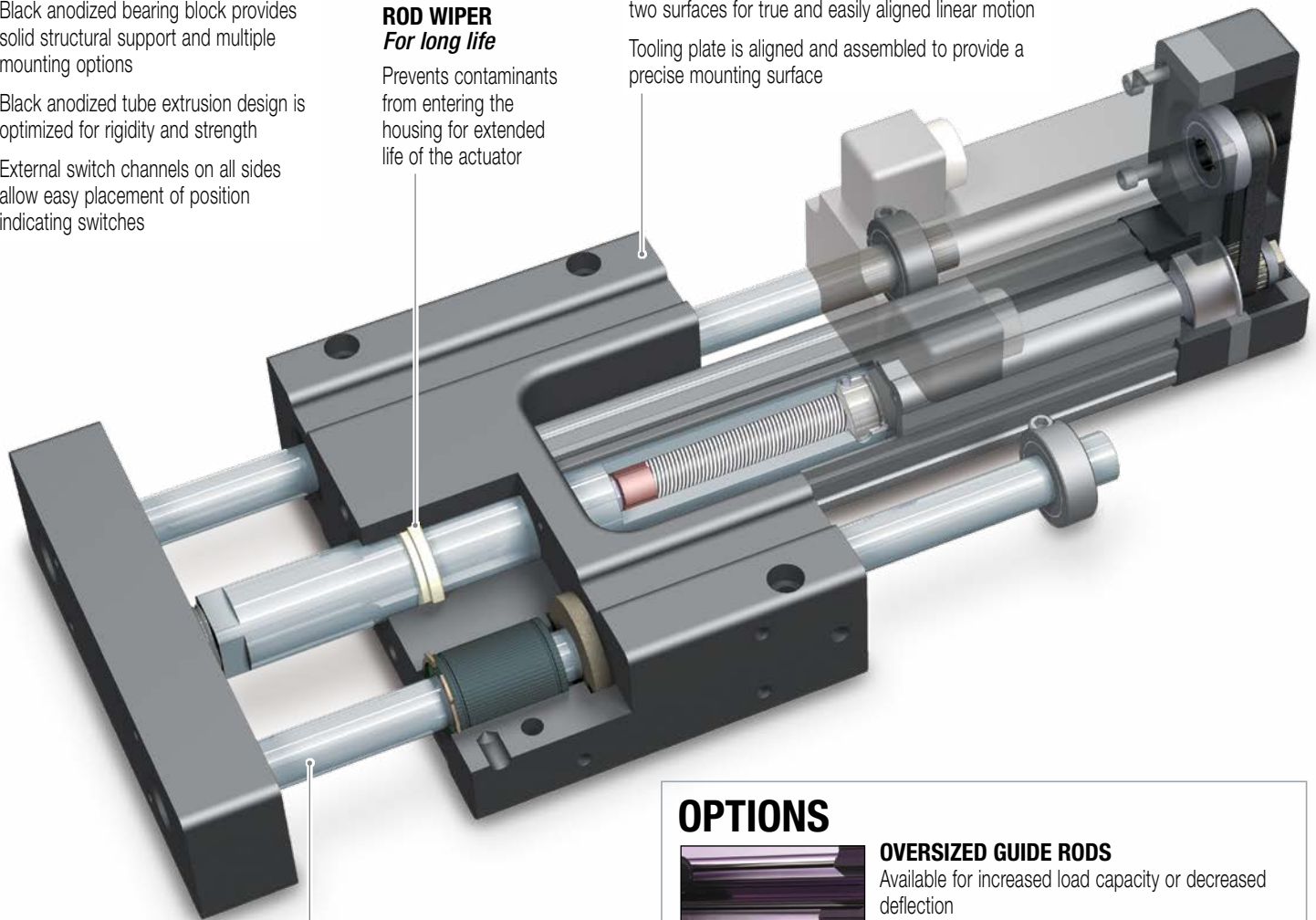

INTEGRAL GUIDE RODS AND BEARINGS Accommodates high bending moments

Hardened steel guide rods provide high rigidity and low deflection

Four composite or linear ball bearings support the load for smooth, consistent motion

Lubrication wick supplies lube for life of actuator

Oversized rods available for higher load capacity

Stainless steel shafting option available for corrosion resistance

OPTIONS



OVERSIZED GUIDE RODS

Available for increased load capacity or decreased deflection



STOP COLLARS

Provide a positive stop mechanism when required

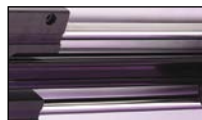

CORROSION RESISTANCE

Includes 316 stainless steel guide rods and fasteners for better environmental protection

METRIC OPTION

Provides metric tapped holes for mounting of load to tooling plate and of actuator to mating surfaces



SWITCHES

Choose from: Reed, Solid State PNP or NPN, all available normally open or normally closed

GSA-HT GUIDED SCREW-DRIVE ACTATOR

The HT option on the GSA (pictured below) is a high torque variation that is ideal for higher force applications. This option allows for roller screws to be utilized along with a higher torque transmission motor mount design.

Yellow background =
HT ONLY FEATURES

INTERNAL BUMPERS *Protects hardware*

Bumpers protect the screw and nut assembly from damage at both ends of stroke

MULTIPLE SCREW TECHNOLOGIES

You can choose:

Solid nuts of bronze or engineered resins offer quiet performance at the lowest cost; anti-backlash available

Ball nuts offer efficiency at a cost effective price; low-backlash available

Roller screws provide the highest force and life ratings available



MOTOR ORIENTATION

You can choose:

Inline option directly couples the driving shaft and is typically a one-piece housing construction for optimum alignment and support of the motor

Reverse-parallel option minimizes the overall length, coupling motor and driving shaft via a belt with a 1:1 or 2:1 reduction ratio

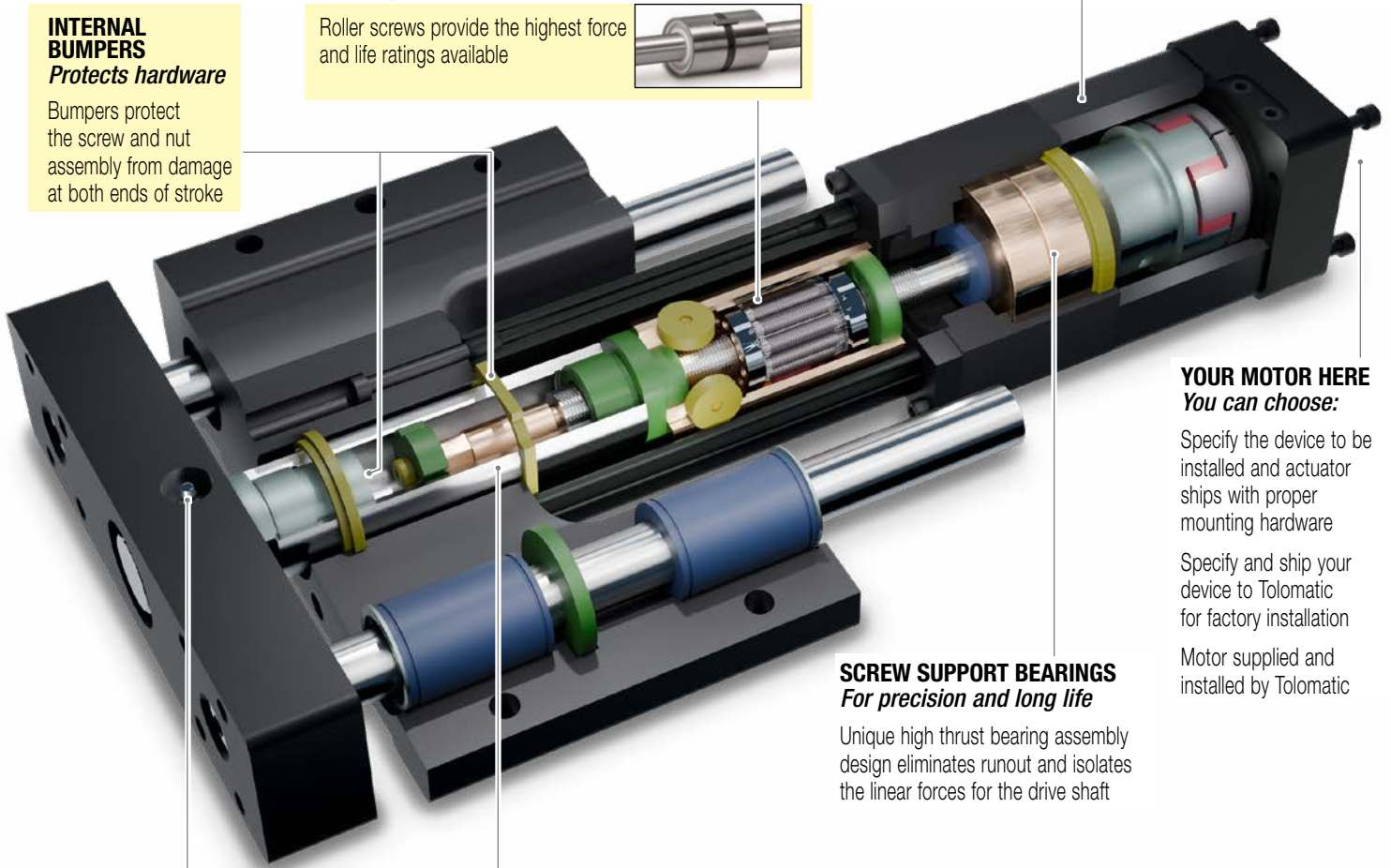

YOUR MOTOR HERE *You can choose:*

Specify the device to be installed and actuator ships with proper mounting hardware

Specify and ship your device to Tolomatic for factory installation

Motor supplied and installed by Tolomatic

SCREW SUPPORT BEARINGS *For precision and long life*

Unique high thrust bearing assembly design eliminates runout and isolates the linear forces for the drive shaft

GREASE ZERK *Convenient lubrication without disassembly*

This relubrication system provides extended screw service life

Standard with all HT actuators

STEEL THRUST TUBE and TOOLING PLATE *For strength and life*

Salt bath nitride treatment provides excellent protection from many chemicals

GSA GUIDED SCREW-DRIVE ACTUATOR



sizeit.tolomatic.com
for fast, accurate
actuator selection

units: **US standard**

GSA SIZE	MAX. STROKE in	SCREW TYPE	SCREW LEAD turns/in	MAX THRUST* lbf	DYNAMIC LOAD RATING** lbf	LEAD ACCURACY† in/ft	BACKLASH in	SCREW DIAMETER in	BASE ACTUATOR INERTIA lb-in ²	INERTIA PER/in OF STROKE lb-in ²	MAXIMUM DYNAMIC FRICTION TORQUE	
											LB lb-in	CB & COB lb-in
12	18	SN01	1.00	70	NA	0.010	0.007	0.375	0.044	0.006	2.9	5.6
	18	SN02	2.00	70	NA	0.006	0.007	0.375	0.013	0.002	1.5	2.8
	18	SN05	5.00	70	NA	0.006	0.007	0.375	0.004	0.001	0.6	1.1
	18	BZ10	10.00	70	NA	0.006	0.008	0.375	0.003	0.001	0.4	0.8
	18	BN(L)08	8.00	130	300	0.003	0.015	0.375	0.003	0.001	0.5	0.7
16	24	SN01	1.00	70	NA	0.010	0.007	0.375	0.079	0.008	2.9	6.1
	24	SN02	2.00	70	NA	0.006	0.007	0.375	0.022	0.002	1.5	3.1
	24	SN05	5.00	70	NA	0.006	0.007	0.375	0.006	0.001	0.6	1.3
	24	BZ10	10.00	70	NA	0.006	0.008	0.375	0.004	0.001	0.4	0.9
	24	BN(L)08	8.00	130	300	0.003	0.015	0.375	0.004	0.001	0.5	0.7
24	30	BZ10	10.00	600	NA	0.006	0.008	0.625	0.077	0.004	4.2	4.0
	30	BN(L)05	5.00	830	1,410	0.003	0.015	0.625	0.081	0.005	2.9	2.7
	30	BN(L)02	2.00	340	1,070	0.003	0.015	0.500	0.115	0.006	2.9	2.7
	30	BNM05	5.08	870	2,700	0.004	0.003	0.630	0.081	0.005	3.0	2.8
	30	BNM10	2.54	430	1,910	0.004	0.003	0.630	0.100	0.006	3.0	2.8
32	36	BZ10	10.00	790	NA	0.006	0.008	0.750	0.126	0.009	5.5	6.1
	36	BN(L)05	5.00	950	1,620	0.003	0.015	0.750	0.135	0.010	4.2	4.8
	36	BN(L)02	2.00	530	3,360	0.004	0.015	0.750	0.194	0.014	4.2	4.8
	36	BNM05	5.08	1,360	3,080	0.004	0.003	0.787	0.134	0.012	4.4	5.0
	36	BNM10	2.54	680	4,720	0.004	0.003	0.787	0.167	0.014	4.4	5.0
	36	BNM20	1.27	340	2,560	0.002	0.005	0.787	0.299	0.025	4.4	5.0

24 HT	30	RN04	6.35	1,700	5,580	0.0004	0.0012	0.591	0.09	0.037	6.3	6.1
	30	RN05	5.08	1,700	5,580	0.0004	0.0012	0.591	0.10	0.040	4.7	4.5
	30	RN10	2.54	1,560	5,580	0.0004	0.0012	0.591	0.13	0.057	6.7	6.5
32 HT	36	BZ10	10.00	2,500	NA	0.006	0.008	0.750	0.13	0.009	5.5	6.1
	36	BN(L)05	5.00	950	1,620	0.003	0.015	0.750	0.13	0.010	4.3	4.9
	36	BN(L)02	2.00	2,500	3,360	0.004	0.015	0.750	0.19	0.014	4.3	4.9
	36	BNM05	5.08	1,790	3,080	0.004	0.003	0.787	0.16	0.012	4.0	4.6
	36	BNM10	2.54	2,470	4,720	0.004	0.003	0.787	0.22	0.015	4.0	4.6
	36	BNM20	1.27	2,360	2,560	0.002	0.005	0.787	0.46	0.025	4.0	4.6
	36	RN04	6.35	4,160	12,760	0.0004	0.0012	0.787	1.18	0.011	9.9	10.6
	36	RN05	5.08	3,880	12,760	0.0004	0.0012	0.787	1.18	0.012	10.3	10.9
	36	RN10	2.54	4,160	12,760	0.0004	0.0012	0.787	1.25	0.015	10.8	11.4

SCREW CODE	DESCRIPTION	SCREW CODE	DESCRIPTION
BN	Ball Nut	BZ	Bronze Nut
BNL	Low-Backlash Ball Nut	RN	Roller Nut
BNM	Ball Nut Metric	SN	Solid Nut



Contact Tolomatic for higher accuracy and lower backlash options.
† (L) for low backlash ball screws: backlash = 0.0020" (0.05 mm)

* For SN & BZ screws, maximum continuous dynamic thrust subject to Thrust x Velocity limitation.

** For RN, BN & BNL screws, dynamic load rating reflects 90% reliability for 1 million revolutions.

GSA GUIDED SCREW-DRIVE ACTUATOR



sizeit.tolomatic.com
for fast, accurate
actuator selection

units: **metric**

GSA SIZE	MAX. STROKE	SCREW TYPE	SCREW LEAD	MAX THRUST*	DYNAMIC LOAD RATING**	LEAD ACCURACY†	BACKLASH	SCREW DIAMETER	BASE ACTUATOR INERTIA	INERTIA PER/in OF STROKE	MAXIMUM DYNAMIC FRICTION TORQUE	
	mm										mm/rev	N
											N-m	N-m
12	457.2	SN01	25.40	310	NA	0.25	0.18	9.5	0.13	0.0006	0.33	0.64
	457.2	SN02	12.70	310	NA	0.15	0.18	9.5	0.04	0.0002	0.17	0.32
	457.2	SN05	5.08	310	NA	0.15	0.18	9.5	0.01	0.0001	0.06	0.13
	457.2	BZ10	2.54	310	NA	0.15	0.20	9.5	0.01	0.0001	0.05	0.09
	457.2	BN(L)08	3.18	580	1,330	0.08	0.38	9.5	0.01	0.0001	0.06	0.08
16	609.6	SN01	25.40	310	NA	0.25	0.18	9.5	0.23	0.0009	0.33	0.69
	609.6	SN02	12.70	310	NA	0.15	0.18	9.5	0.06	0.0003	0.17	0.35
	609.6	SN05	5.08	310	NA	0.15	0.18	9.5	0.02	0.0001	0.06	0.14
	609.6	BZ10	2.54	310	NA	0.15	0.20	9.5	0.01	0.0001	0.05	0.11
	609.6	BN(L)08	3.18	580	1,330	0.08	0.38	9.5	0.01	0.0001	0.06	0.08
24	762.0	BZ10	2.54	2,670	NA	0.08	0.38	15.9	0.22	0.0005	0.47	0.45
	762.0	BN(L)05	5.08	3,690	6,300	0.08	0.38	15.9	0.24	0.0005	0.33	0.31
	762.0	BN(L)02	12.70	1,510	4,800	0.08	0.38	12.7	0.34	0.0007	0.33	0.31
	762.0	BNM05	5.00	3,870	12,000	0.08	0.38	16.0	0.24	0.0006	0.34	0.32
	762.0	BNM10	10.00	1,910	8,500	0.08	0.38	16.0	0.29	0.0007	0.34	0.32
32	914.4	BZ10	2.54	3,510	NA	0.08	0.38	19.1	0.37	0.0010	0.62	0.69
	914.4	BN(L)05	5.08	4,230	7,200	0.08	0.38	19.1	0.39	0.0011	0.47	0.54
	914.4	BN(L)02	12.70	2,360	14,900	0.08	0.38	20.0	0.57	0.0016	0.47	0.54
	914.4	BNM05	5.00	6,050	13,700	0.10	0.07	20.0	0.39	0.0014	0.50	0.56
	914.4	BNM10	10.00	3,020	21,000	0.10	0.07	20.0	0.49	0.0017	0.50	0.56
	914.4	BNM20	20.00	1,510	11,400	0.05	0.13	20.0	0.88	0.0028	0.50	0.56

24 HT	762.0	RN04	4.00	7,600	24,800	0.01	0.03	15.0	0.27	0.0043	0.71	0.69
	762.0	RN05	5.00	7,600	24,800	0.01	0.03	15.0	0.28	0.0046	0.53	0.51
	762.0	RN10	10.00	6,900	24,800	0.01	0.03	15.0	0.38	0.0066	0.76	0.73
32 HT	914.4	BZ10	2.54	11,100	NA	0.15	0.20	19.1	0.37	0.0010	0.62	0.69
	914.4	BN(L)05	5.08	4,200	7,200	0.10	0.38	19.1	0.39	0.0016	0.49	0.55
	914.4	BN(L)02	12.70	11,100	14,900	0.08	0.38	19.1	0.57	0.0011	0.49	0.55
	914.4	BNM05	5.00	8,000	13,700	0.10	0.07	20.0	0.48	0.0014	0.45	0.52
	914.4	BNM10	10.00	11,000	21,000	0.10	0.07	20.0	0.65	0.0017	0.45	0.52
	914.4	BNM20	20.00	10,500	11,400	0.05	0.13	20.0	1.35	0.0028	0.45	0.52
	914.4	RN04	4.00	18,500	56,800	0.01	0.03	20.0	3.45	0.0013	1.12	1.20
	914.4	RN05	5.00	17,300	56,800	0.01	0.03	20.0	3.47	0.0013	1.16	1.23
914.4	RN10	10.00	18,500	56,800	0.01	0.03	20.0	3.66	0.0017	1.22	1.29	

SCREW CODE	DESCRIPTION	SCREW CODE	DESCRIPTION
BN	Ball Nut	BZ	Bronze Nut
BNL	Low-Backlash Ball Nut	RN	Roller Nut
BNM	Ball Nut Metric	SN	Solid Nut



Contact Tolomatic for higher accuracy and lower backlash options.
† (L) for low backlash ball screws: backlash = 0.0020" (0.05 mm)

* For SN & BZ screws, maximum continuous dynamic thrust subject to Thrust x Velocity limitation.

** For RN, BN & BNL screws, dynamic load rating reflects 90% reliability for 1 million revolutions.

GSA GUIDED SCREW-DRIVE ACTUATOR



sizeit.tolomatic.com
for fast, accurate
actuator selection

units: **US standard**

GSA SIZE	ACTUATOR WEIGHT								
	BASE	MOTOR MOUNT			PER LENGTH OF STROKE		MOTOR MOUNT INERTIA		
		lb	LMI lb	RP1 lb	RP2 lb	LB & CB lb/in	COB lb/in	LMI lb-in ²	RP1 lb-in ²
12 ST	3.4	0.9	0.7	NA	0.21	0.27	0.03	0.15	NA
16 ST	6.8	0.9	0.8	NA	0.30	0.38	0.03	0.15	NA
24 ST	13.6	0.9	1.7	2.2	0.54	0.74	0.03	0.15	0.12
32 ST	25.9	1.4	2.8	3.2	0.93	1.19	0.18	0.16	0.16
24 HT	17.9	2.4	2.5	2.2	0.60	0.81	0.56	0.38	0.11
32 HT BN	25.9	5.4	2.9	3.3	1.07	1.33	2.35	0.25	0.18
32 HT RN	38.7	5.2	5.7	6.0	1.07	1.33	2.35	1.38	0.66

units: **metric**

GSA SIZE	ACTUATOR WEIGHT								
	BASE	MOTOR MOUNT			PER LENGTH OF STROKE		MOTOR MOUNT INERTIA		
		kg	LMI kg	RP1 kg	RP2 kg	LB & CB kg/mm	COB kg/mm	LMI kg-cm ²	RP1 kg-cm ²
12 ST	1.5	0.4	0.3	NA	0.004	0.005	0.09	0.44	NA
16 ST	3.1	0.4	0.4	NA	0.005	0.007	0.09	0.44	NA
24 ST	6.2	0.4	0.8	1.0	0.010	0.013	0.09	0.44	0.36
32 ST	11.7	0.6	1.3	1.4	0.017	0.021	0.53	0.46	0.47
24 HT	8.1	1.1	1.1	1.0	0.011	0.014	1.65	1.13	0.31
32 HT BN	11.7	2.4	1.3	1.5	0.019	0.024	6.88	0.72	0.53
32 HT RN	17.6	2.3	2.6	2.7	0.019	0.024	6.88	4.06	1.93

SIZE: 12,16: CRITICAL SPEED CAPACITIES

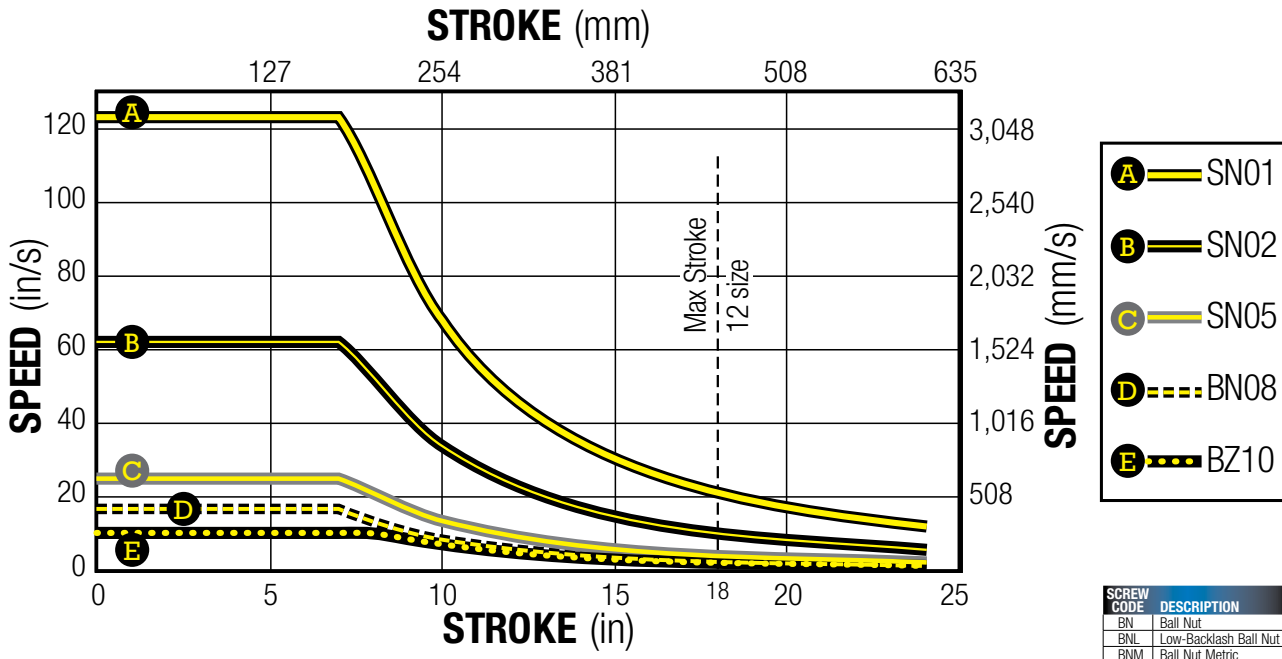

SCREW CODE	DESCRIPTION	SCREW CODE	DESCRIPTION
BN	Ball Nut	BZ	Bronze Nut
BNL	Low-Backlash Ball Nut	RN	Roller Nut
BNM	Ball Nut Metric	SN	Solid Nut

SIZE: **24: CRITICAL SPEED CAPACITIES**

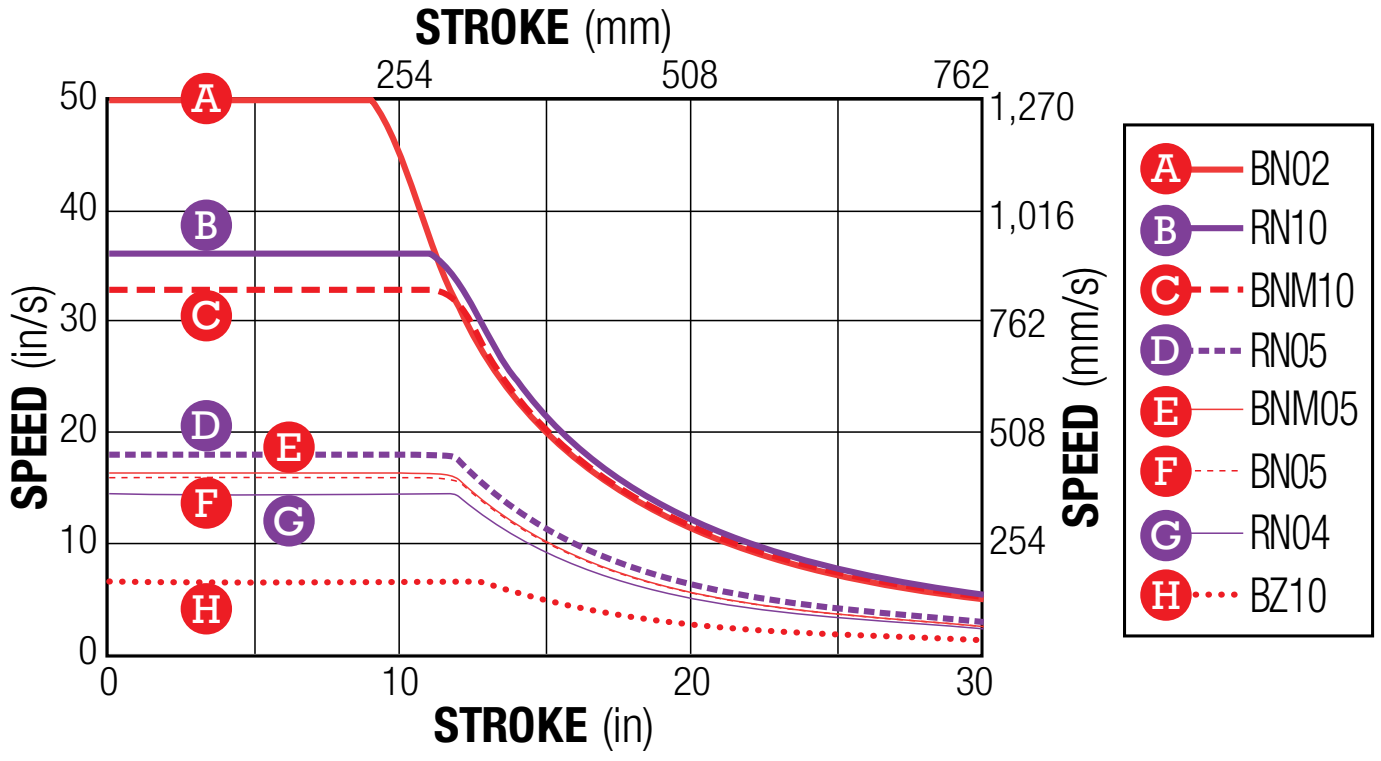

SIZE: **32: CRITICAL SPEED CAPACITIES**

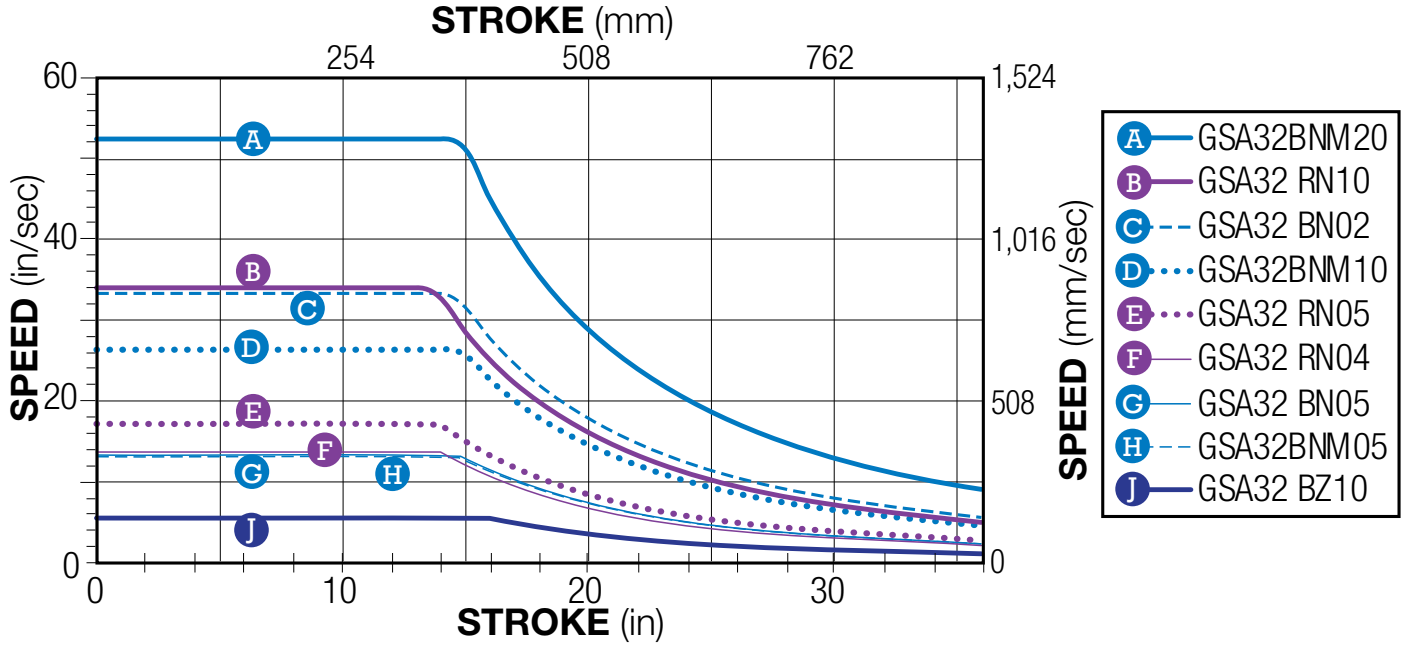

SCREW CODE	DESCRIPTION	SCREW CODE	DESCRIPTION
BN	Ball Nut	BZ	Bronze Nut
BNL	Low-Backlash Ball Nut	RN	Roller Nut
BNM	Ball Nut Metric	SN	Solid Nut



SIZE: 12,16: PV LIMITS (Solid Nuts)

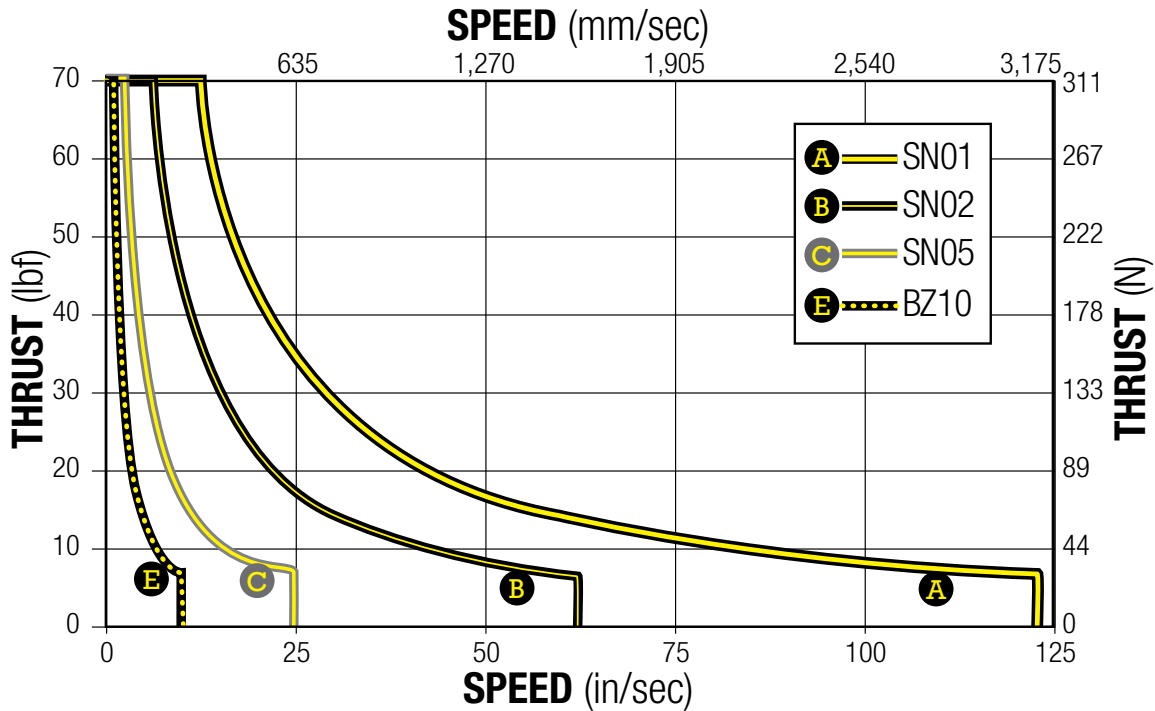

SIZE: 24,32 (BZ): PV LIMITS (Bronze Nuts)

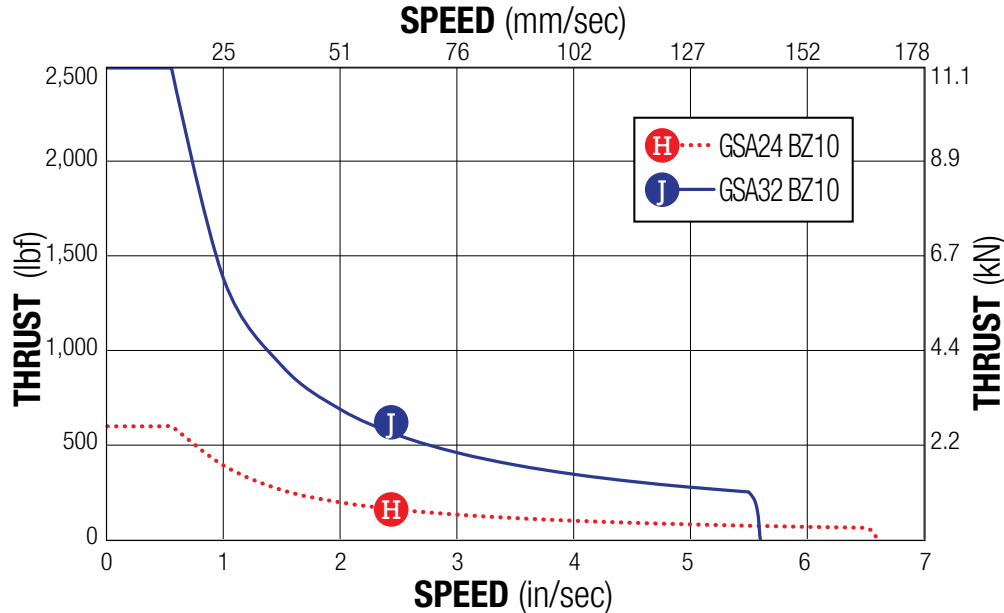

PV LIMITS

PV LIMITS: Any material which carries a sliding load is limited by heat buildup. The factors that affect heat generation rate in an application are the pressure on the nut in pounds per square inch and the surface velocity in feet per minute. The product of these factors provides a measure of the severity of an application.

$$P \times V \leq 0.1$$

$$\left(\frac{\text{Thrust}}{\text{Max. Thrust Rating}} \right) \times \left(\frac{\text{Speed}}{\text{Max. Speed Rating}} \right) \leq 0.1$$

SCREW CODE	DESCRIPTION	SCREW CODE	DESCRIPTION
BN	Ball Nut	BZ	Bronze Nut
BNL	Low-Backlash Ball Nut	RN	Roller Nut
BNM	Ball Nut Metric	SN	Solid Nut

ST SCREW BUCKLING LOAD

SIZE: 12, 16, 24

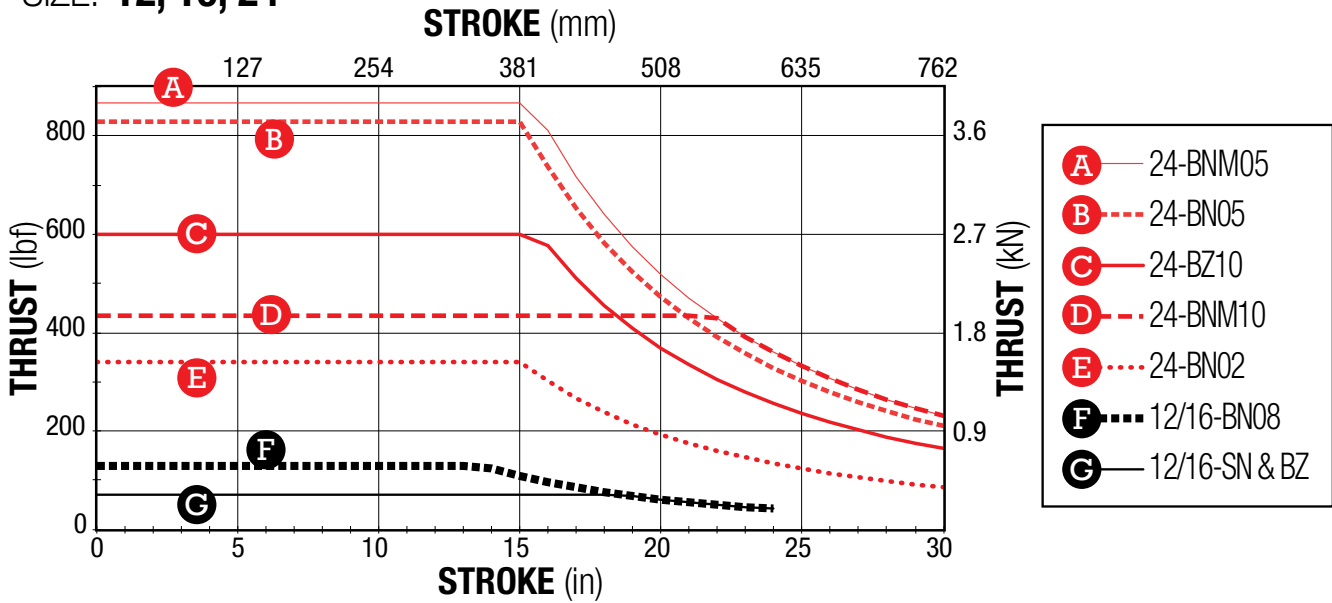

ST SCREW BUCKLING LOAD

SIZE: 32

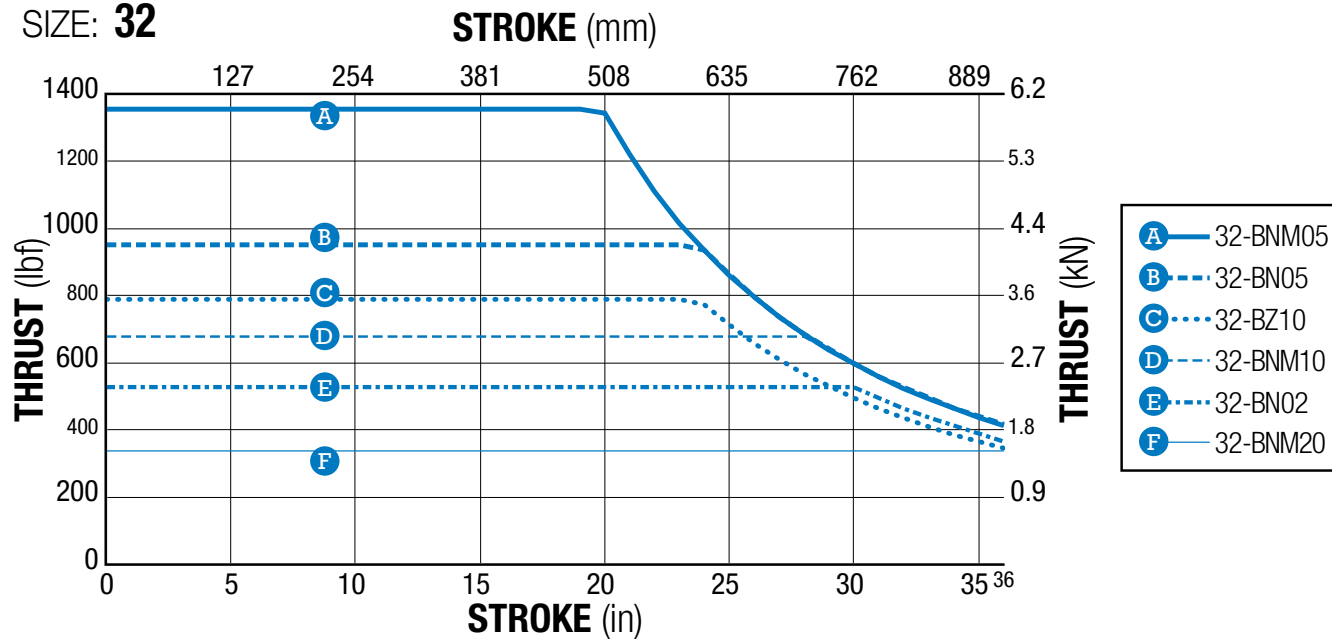

⚠ NOTE: Buckling load limits shown assume perfect alignment. It is recommended to use additional safety margin, particularly in high thrust applications

SCREW CODE	DESCRIPTION	SCREW CODE	DESCRIPTION
BN	Ball Nut	BZ	Bronze Nut
BNL	Low-Backlash Ball Nut	RN	Roller Nut
BNM	Ball Nut Metric	SN	Solid Nut

HT ROLLER SCREW BUCKLING LOAD

SIZE: **24, 32**

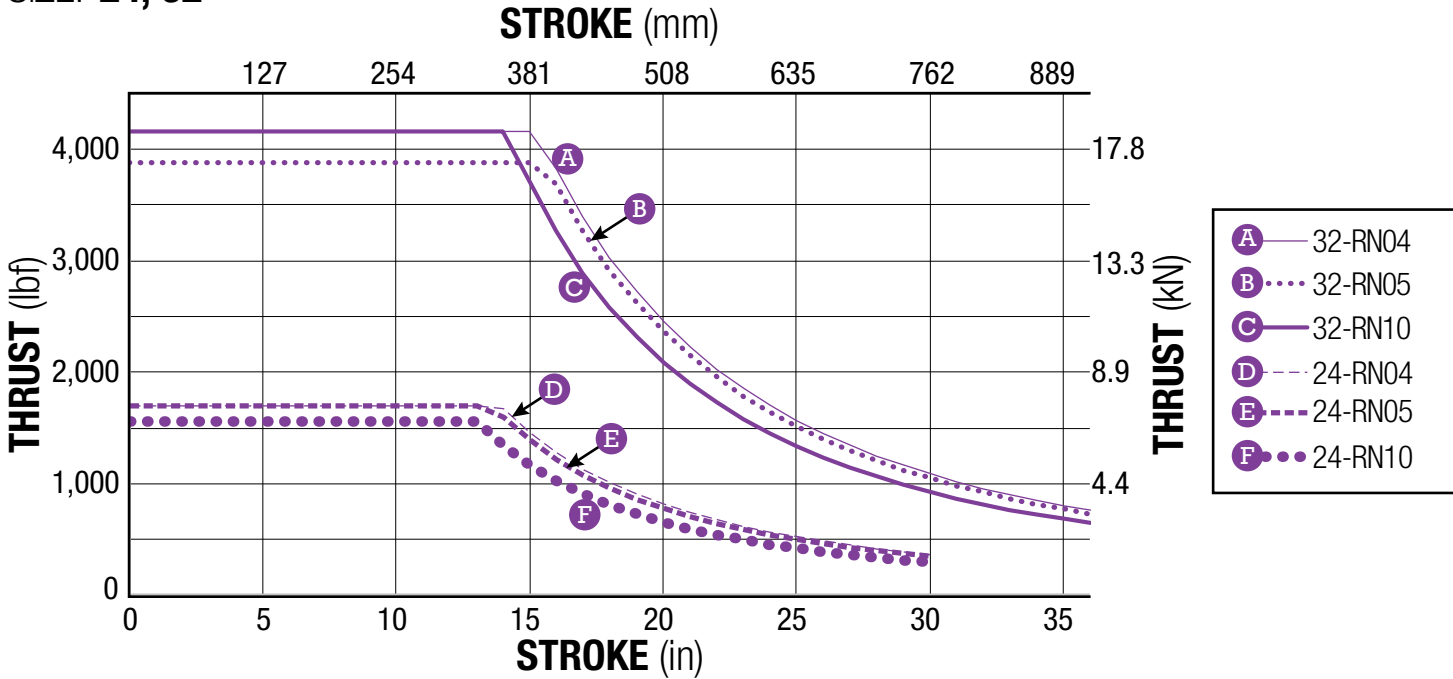

HT SCREW BUCKLING LOAD

SIZE: **32**

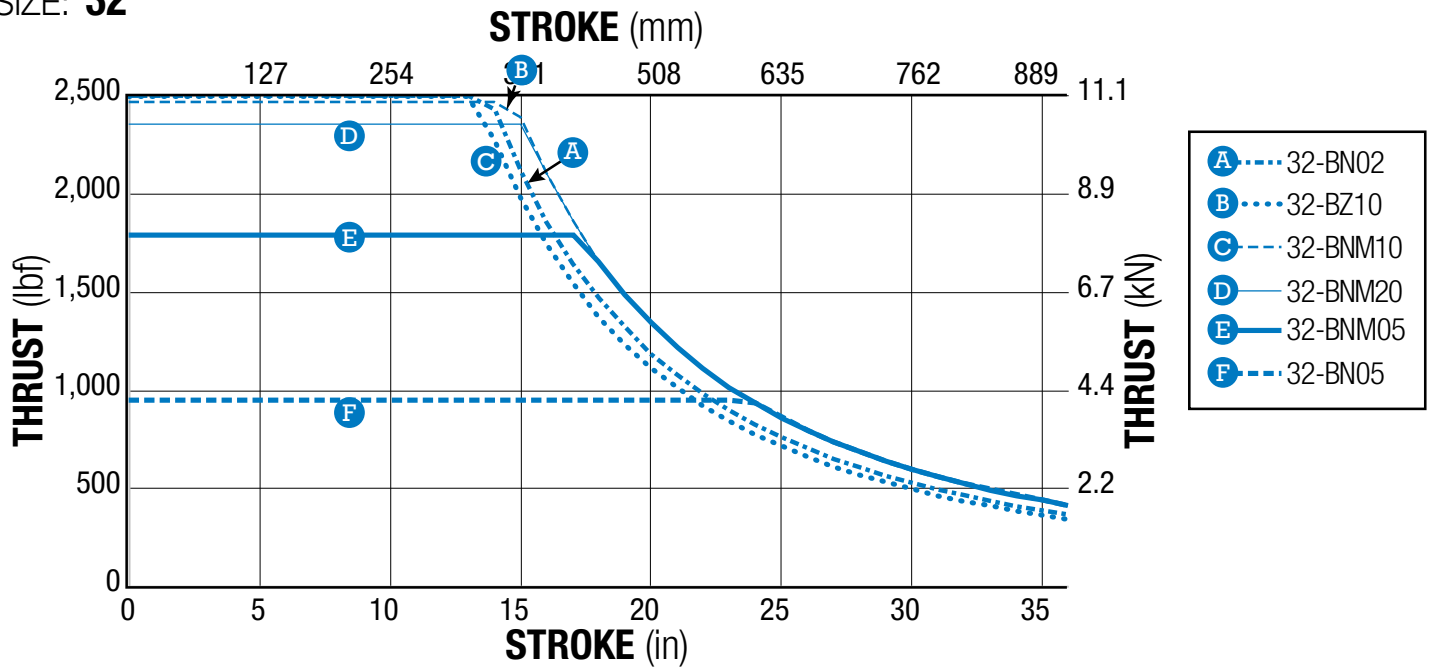

⚠ NOTE: Buckling load limits shown assume perfect alignment. It is recommended to use additional safety margin, particularly in high thrust applications

SCREW CODE	DESCRIPTION	SCREW CODE	DESCRIPTION
BN	Ball Nut	BZ	Bronze Nut
BNL	Low-Backlash Ball Nut	RN	Roller Nut
BNM	Ball Nut Metric	SN	Solid Nut

BALL SCREW LIFE GRAPHS

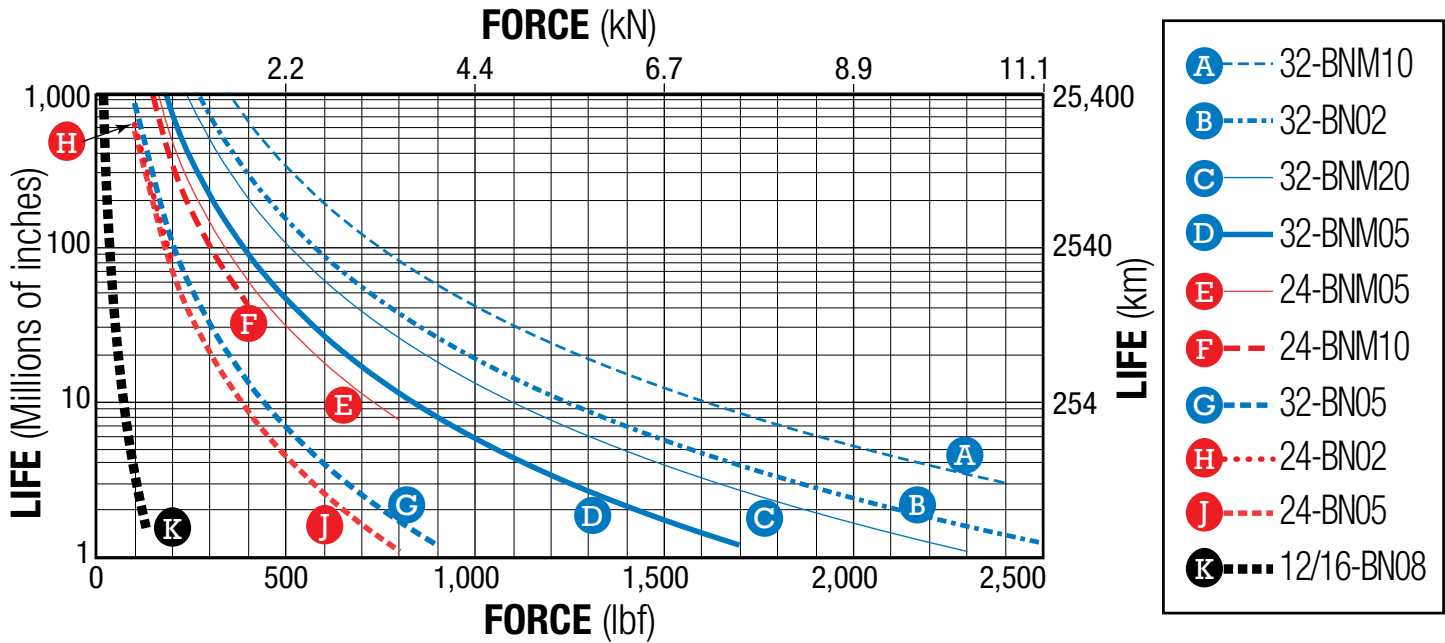

ROLLER SCREW LIFE GRAPHS

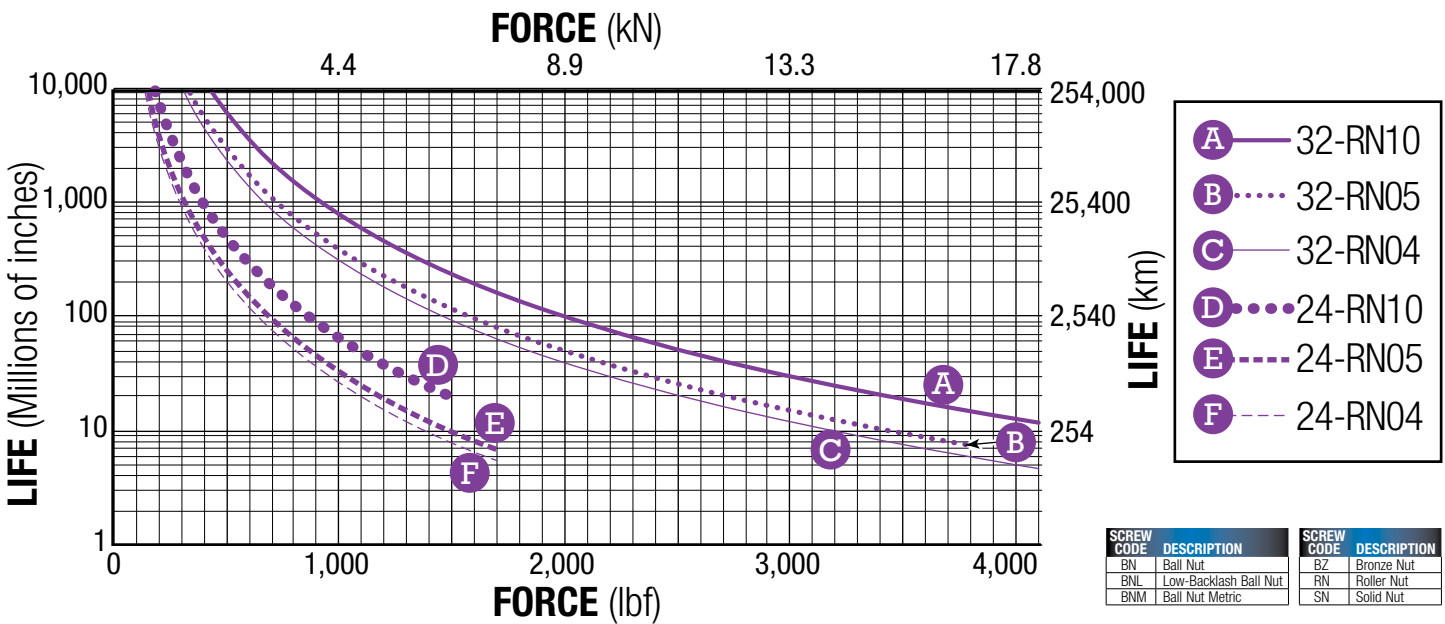

SCREW CODE	DESCRIPTION	SCREW CODE	DESCRIPTION
BN	Ball Nut	BZ	Bronze Nut
BNL	Low-Backlash Ball Nut	RN	Roller Nut
BNM	Ball Nut Metric	SN	Solid Nut

NOTE: The L_{10} expected life of a ball screw linear actuator is expressed as the linear travel distance that 90% of properly maintained ball screw manufactured are expected to meet or exceed. This is not a guarantee and this graph should be used for estimation purposes only.

The underlying formula that defines this value is:

$$L_{10} = \left(\frac{C}{P_e} \right)^3 \cdot \ell =$$

L_{10} Travel life in millions of units (in or mm), where:

C = Dynamic load rating (lbf) or (N)

P_e = Equivalent load (lbf) or (N)

If load is constant across all movements then:

actual load = equivalent load

ℓ = Screw lead (in/rev) (mm/rev)

Use the "Equivalent Load" calculation below, when the load is not constant throughout the entire stroke. In cases where there is only minor variation in loading, use greatest load for life calculations.

$$\text{Where: } P_e = \sqrt[3]{\frac{L_1(P_1)^3 + L_2(P_2)^3 + L_3(P_3)^3 + L_n(P_n)^3}{L}}$$

P_e = Equivalent load (lbf) or (N)

P_n = Each increment at different load (lbf) or (N)

L = Total distanced traveled per cycle (extend + retract stroke)
[$L = L_1 + L_2 + L_3 + L_n$]

L_n = Each increment of stroke at different load (in) or (mm)



To determine the capabilities of a GSA for handling offset loads, follow these steps in conjunction with the corresponding graphs provided on the following pages.

- To obtain the most accurate results, stroke length should be adjusted by the distance between the center of mass of the load and tooling plate.

$$X_{adj} = X_s + X_{cm}$$

Then, use X_{adj} instead of X_s on the “Maximum Load Weight vs. Stroke Length” graphs.

- For the off-center loads, calculate adjusted load weight using the following formula for each GSA size:

GSA12: $W_{adj} = W (1 + 0.67 Y_{cm})$

GSA16: $W_{adj} = W (1 + 0.53 Y_{cm})$

GSA24: $W_{adj} = W (1 + 0.40 Y_{cm})$

GSA32: $W_{adj} = W (1 + 0.53 Y_{cm})$

where Y_{cm} is distance between center of mass of off-center load and center of tooling plate. Then, use W_{adj} instead of W on the “Maximum Load Weight vs. Stroke Length” graphs. Use these adjusted Stroke and Load values to evaluate actuator maximum load capabilities.

- Using your stroke length and load weight, evaluate guide rod deflection. If the intersection point is above the highest curve contact Tolomatic for assistance.

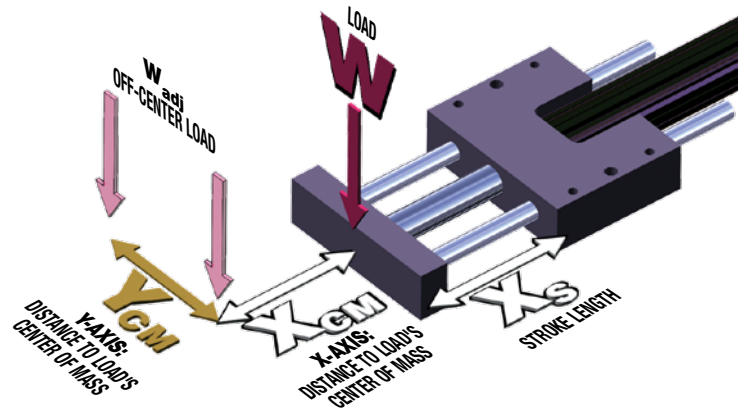

- Maximum load values are based on 200 million linear inches of travel



- Do not exceed maximum load curve
- Impact loading is not recommended for GSA actuators.
- Motor brakes may be required on vertically positioned actuators with plastic (solid), ball nuts, or roller nuts in applications with risk of load backdriving. (Actuators with bronze nuts will not backdrive for loads, thrusts within catalog specifications.)

Questions: Contact Tolomatic for assistance.

EXAMPLE

GSA24 with 8 inches of adjusted stroke, standard size Composite Bearings (CB), and with an adjusted load of 150lb. Load values to evaluate actuator maximum load capabilities.

Using the GSA24 Graphs on Page 17, we can see that the load is under the Maximum allowed load of 250lb, and that the speed of the GSA is limited to just under 10 in/s.

We also see that the guide rod deflection at 8 inches of stroke will be around 0.014”.

MAXIMUM LOAD WEIGHT vs STROKE LENGTH
Composite Bearing, Standard Guide Rods

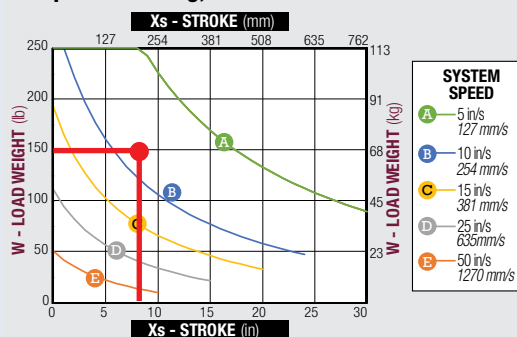

GUIDE ROD DEFLECTION
Standard Guide Rods

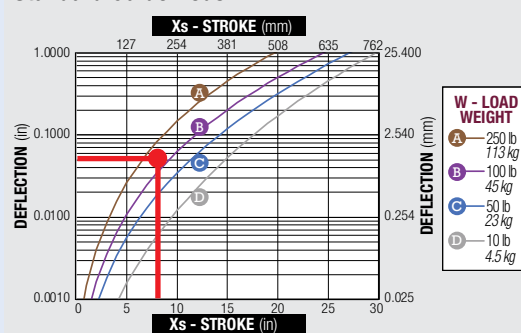



MAXIMUM LOAD WEIGHT vs STROKE LENGTH Linear Ball Bearing, Standard Guide Rods

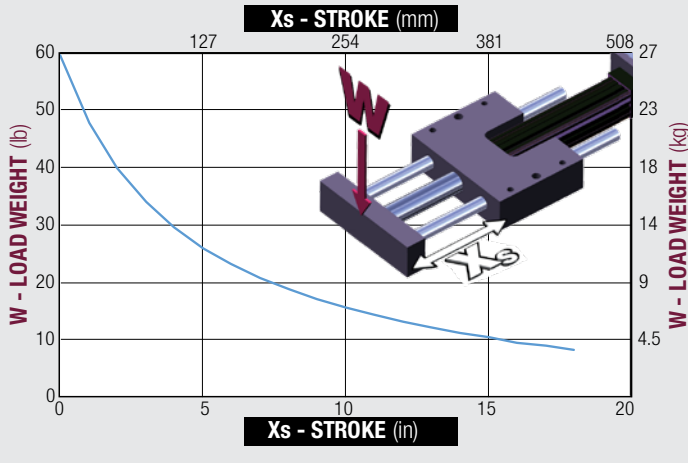

To determine GSA load, travel speed, and deflection capabilities

- Use the steps on page 14 to adjust your load weight and stroke values.
- Use the “Maximum Load Weight vs. Stroke Length” graphs to determine if the bearing is capable of the load intended for the actuator size and if the travel speed is limited
 - For Linear Ball Bearings there is no travel speed reduction for any load and stroke combination
 - For composite bearings, Tolomatic does not recommend operating a GSA with a load and stroke combination above the 5 in/s line
- Use the “Guide Rod Deflection” graphs to determine the amount of deflection the guide system will see with the load and stroke combination
 - Tolomatic does not recommend operating a GSA with a guide rod deflection over 0.5 inches

MAXIMUM LOAD WEIGHT vs STROKE LENGTH Composite Bearing, Standard Guide Rods

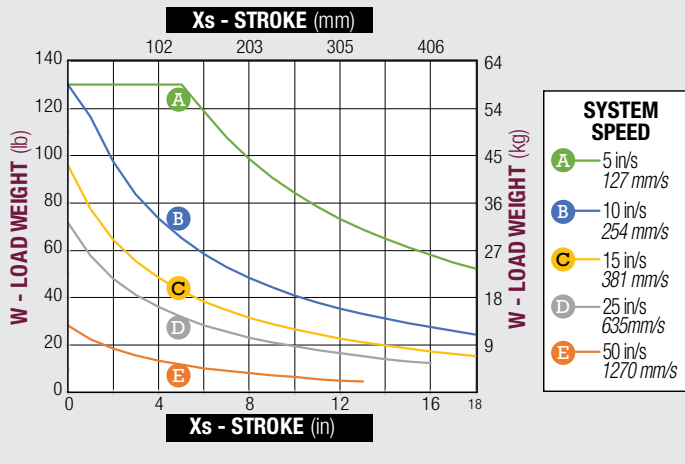

MAXIMUM LOAD WEIGHT vs STROKE LENGTH Composite Bearing, Oversize Guide Rods

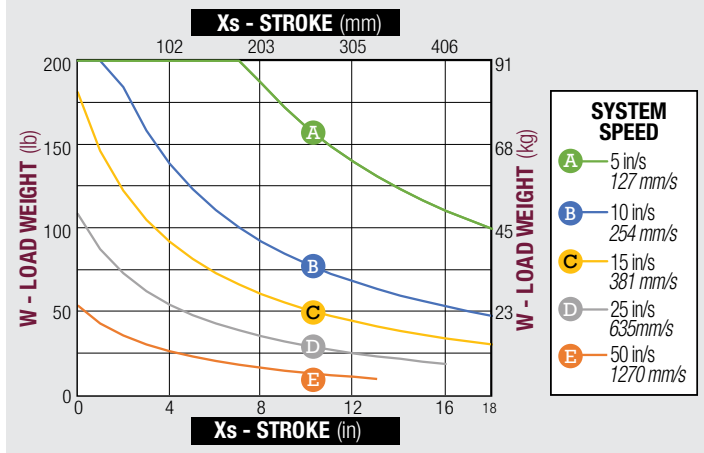

GUIDE ROD DEFLECTION Standard Guide Rods

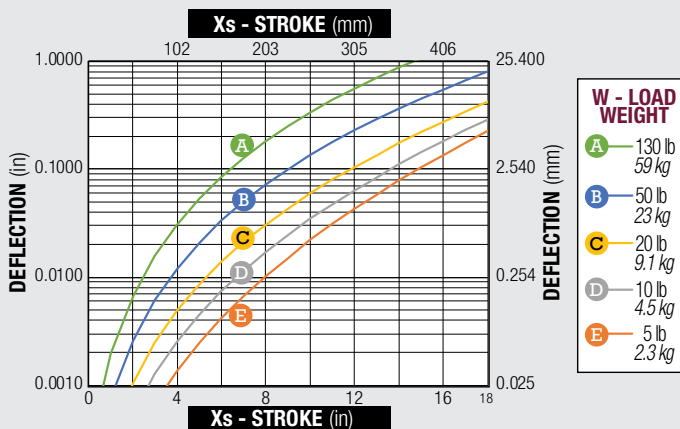

GUIDE ROD DEFLECTION Oversize Guide Rods

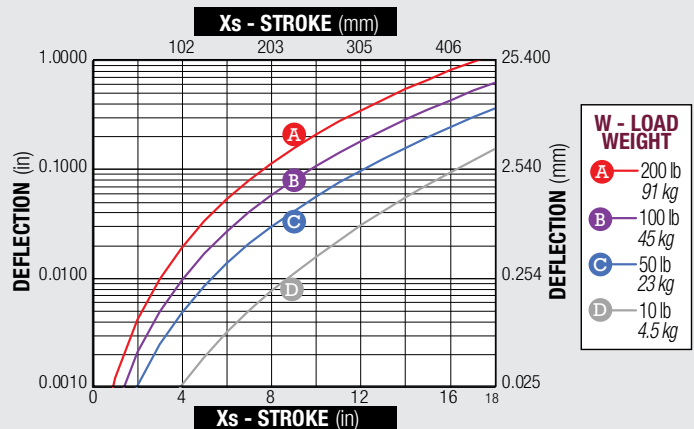



MAXIMUM LOAD WEIGHT vs STROKE LENGTH Linear Ball Bearing, Standard Guide Rods

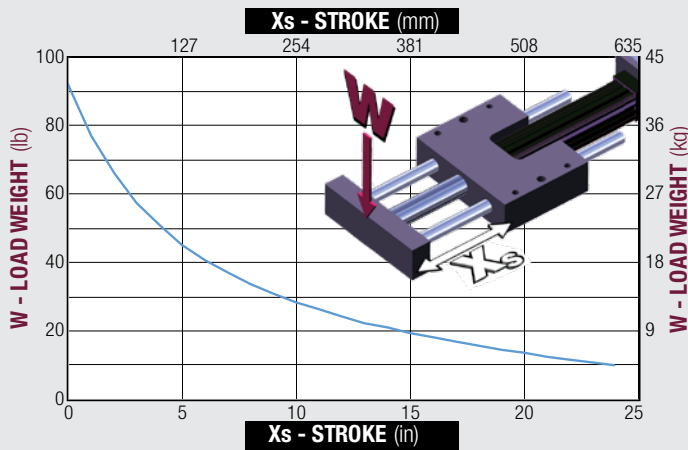

To determine GSA load, travel speed, and deflection capabilities

1. Use the steps on page 14 to adjust your load weight and stroke values.
2. Use the "Maximum Load Weight vs. Stroke Length" graphs to determine if the bearing is capable of the load intended for the actuator size and if the travel speed is limited
 - a. For Linear Ball Bearings there is no travel speed reduction for any load and stroke combination
 - b. For composite bearings, Tolomatic does not recommend operating a GSA with a load and stroke combination above the 5 in/s line
3. Use the "Guide Rod Deflection" graphs to determine the amount of deflection the guide system will see with the load and stroke combination
 - a. Tolomatic does not recommend operating a GSA with a guide rod deflection over 0.5 inches

MAXIMUM LOAD WEIGHT vs STROKE LENGTH Composite Bearing, Standard Guide Rods

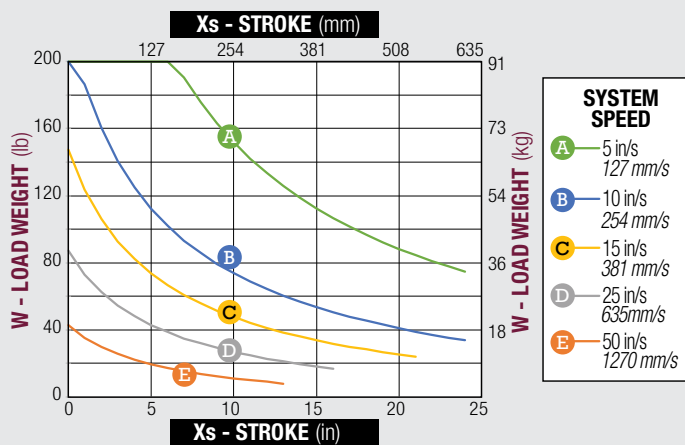

MAXIMUM LOAD WEIGHT vs STROKE LENGTH Composite Bearing, Oversize Guide Rods

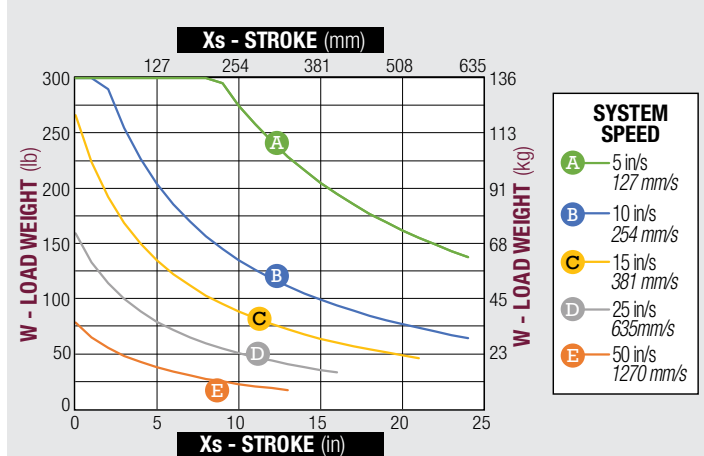

GUIDE ROD DEFLECTION Standard Guide Rods

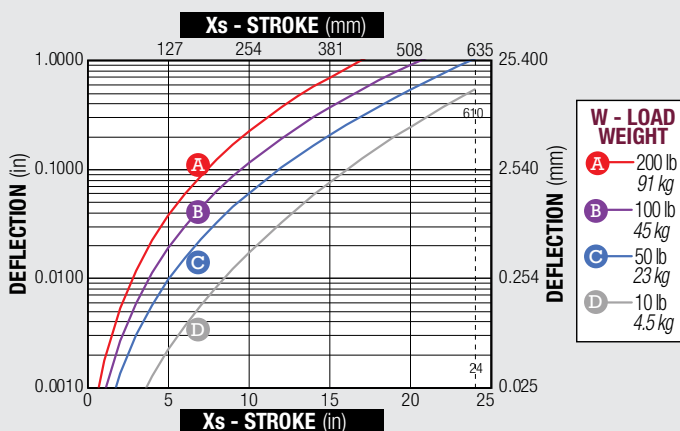

GUIDE ROD DEFLECTION Oversize Guide Rods

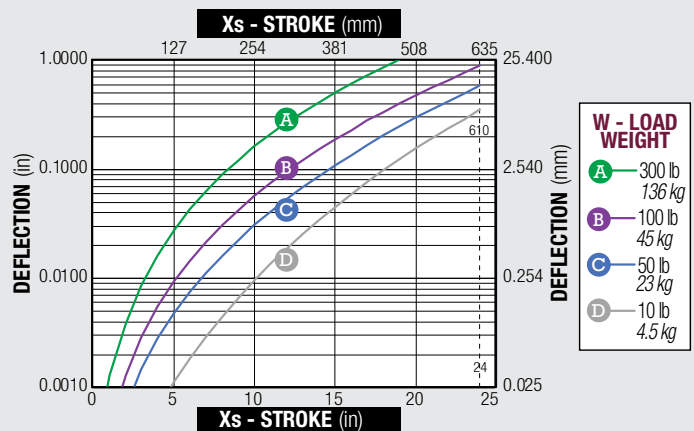

GSA24 GUIDED SCREW-DRIVE ACTUATOR



sizeit.tolomatic.com
for fast, accurate
actuator selection

MAXIMUM LOAD WEIGHT vs STROKE LENGTH Linear Ball Bearing, Standard Guide Rods

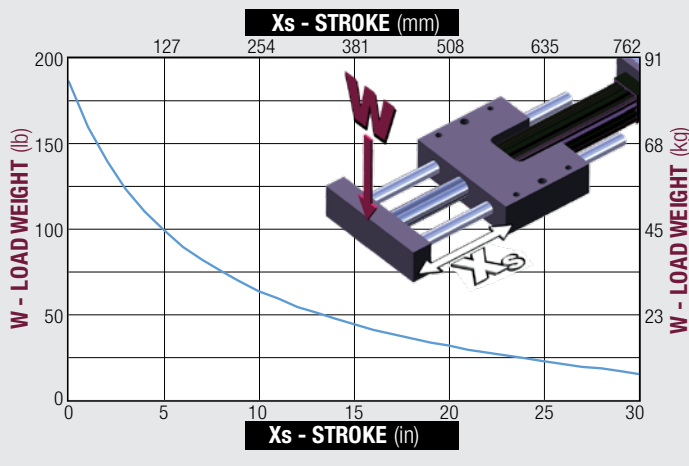

To determine GSA load, travel speed, and deflection capabilities

1. Use the steps on page 14 to adjust your load weight and stroke values.
2. Use the “Maximum Load Weight vs. Stroke Length” graphs to determine if the bearing is capable of the load intended for the actuator size and if the travel speed is limited
 - a. For Linear Ball Bearings there is no travel speed reduction for any load and stroke combination
 - b. For composite bearings, Tolomatic does not recommend operating a GSA with a load and stroke combination above the 5 in/s line
3. Use the “Guide Rod Deflection” graphs to determine the amount of deflection the guide system will see with the load and stroke combination
 - a. Tolomatic does not recommend operating a GSA with a guide rod deflection over 0.5 inches

MAXIMUM LOAD WEIGHT vs STROKE LENGTH Composite Bearing, Standard Guide Rods

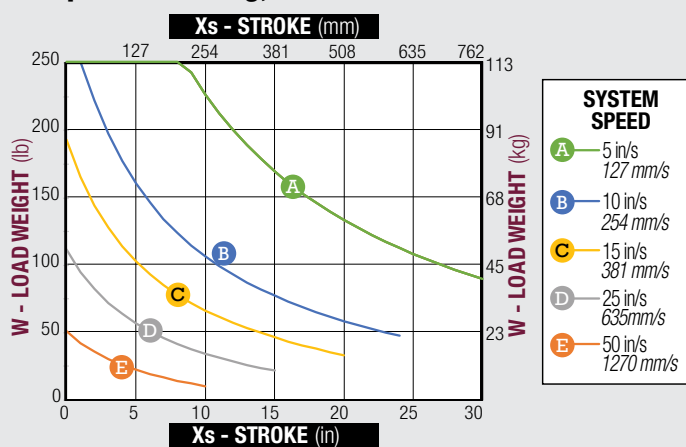

MAXIMUM LOAD WEIGHT vs STROKE LENGTH Composite Bearing, Oversize Guide Rods

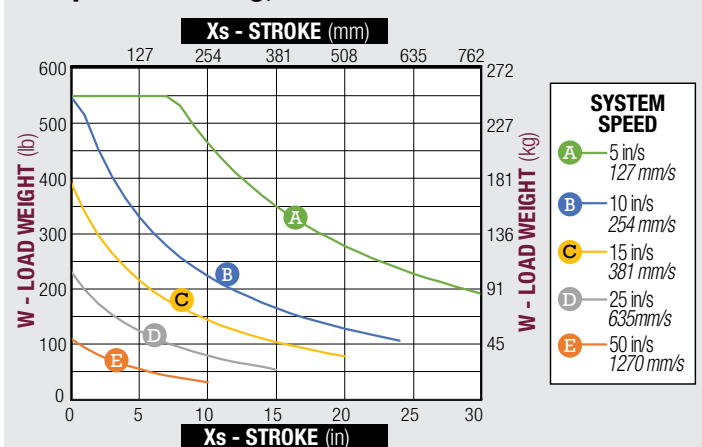

GUIDE ROD DEFLECTION Standard Guide Rods

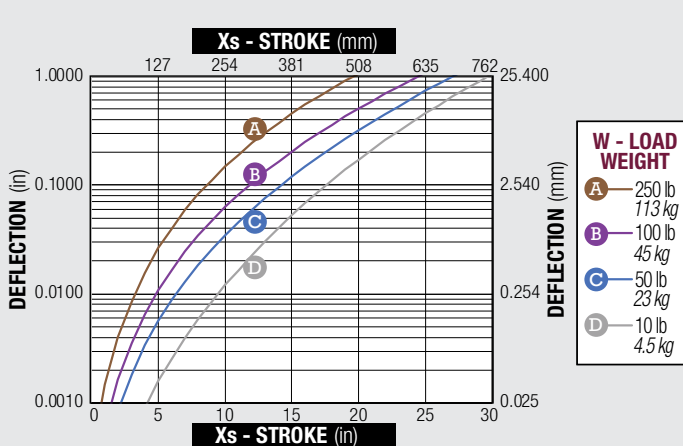

GUIDE ROD DEFLECTION Oversize Guide Rods

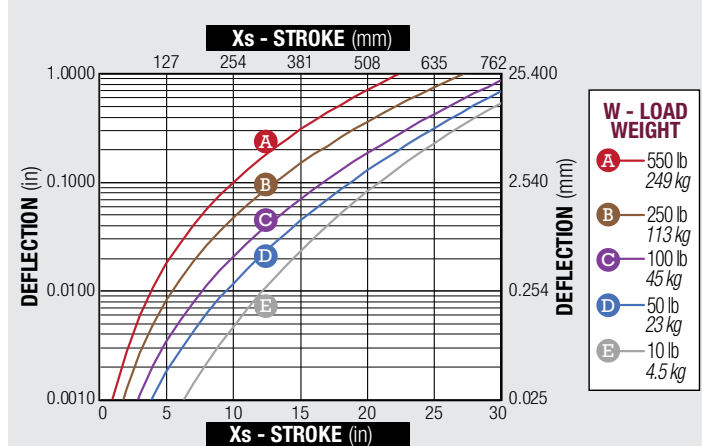



MAXIMUM LOAD WEIGHT vs STROKE LENGTH Linear Ball Bearing, Standard Guide Rods

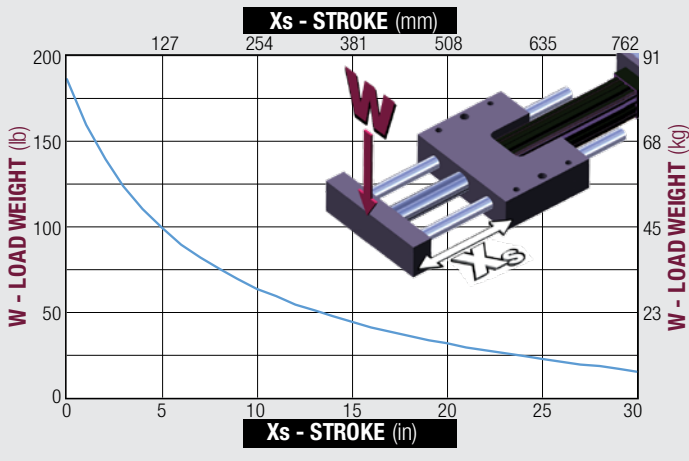

To determine GSA load, travel speed, and deflection capabilities

- Use the steps on page 14 to adjust your load weight and stroke values.
- Use the “Maximum Load Weight vs. Stroke Length” graphs to determine if the bearing is capable of the load intended for the actuator size and if the travel speed is limited
 - For Linear Ball Bearings there is no travel speed reduction for any load and stroke combination
 - For composite bearings, Tolomatic does not recommend operating a GSA with a load and stroke combination above the 5 in/s line
- Use the “Guide Rod Deflection” graphs to determine the amount of deflection the guide system will see with the load and stroke combination
 - Tolomatic does not recommend operating a GSA with a guide rod deflection over 0.5 inches

MAXIMUM LOAD WEIGHT vs STROKE LENGTH Composite Bearing, Standard Guide Rods

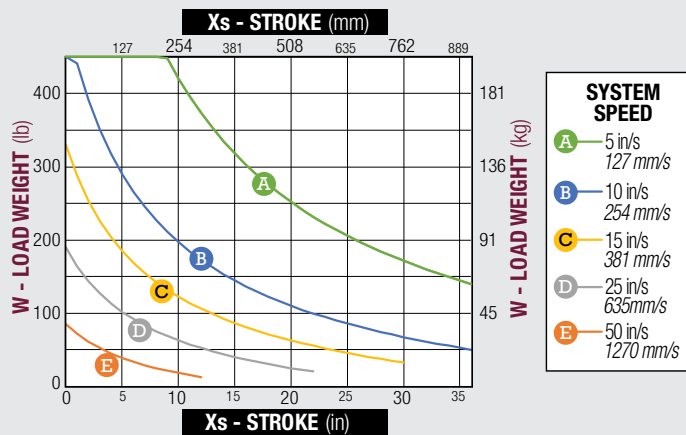

MAXIMUM LOAD WEIGHT vs STROKE LENGTH Composite Bearing, Oversize Guide Rods

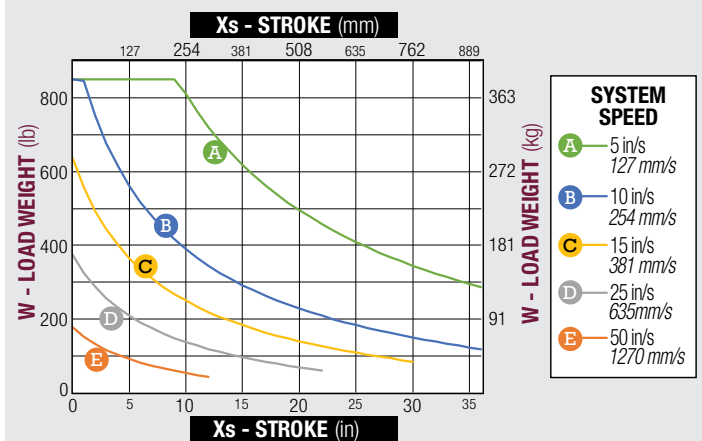

GUIDE ROD DEFLECTION Standard Guide Rods

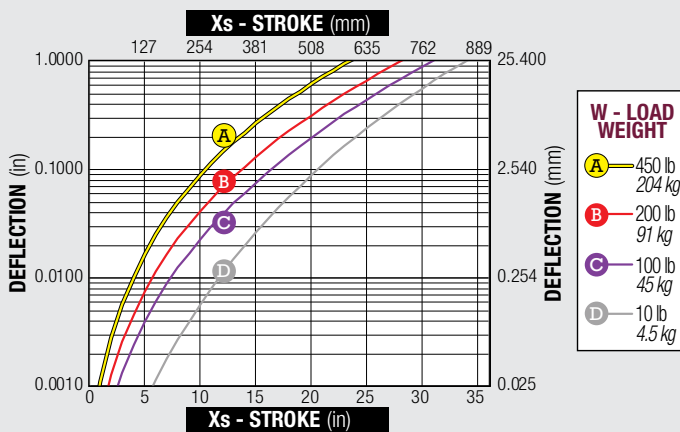

GUIDE ROD DEFLECTION Oversize Guide Rods

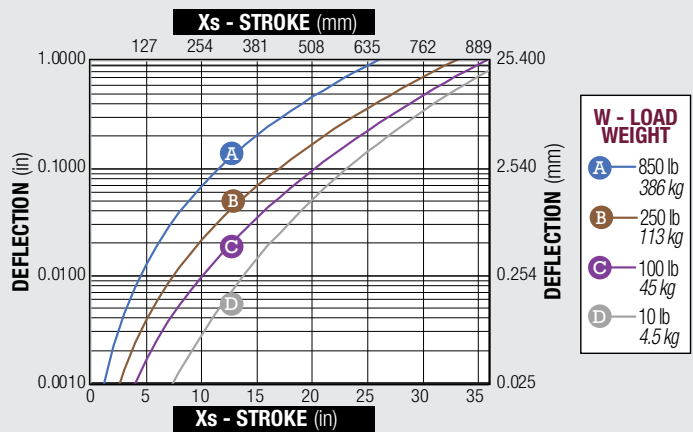

GSA-ST GUIDED SCREW-DRIVE ACTUATOR

tolomatic.com/CAD Download 3D CAD Always use CAD solid model to determine critical dimensions



US Conventional Measurements

	12	16	24	32
A	5.130	6.250	7.750	10.000
B	2.000	2.500	3.500	5.000
C	0.688	1.000	1.375	1.750
D	0.880	1.130	1.380	1.630
E	4.000	5.000	6.000	7.000
F	2.500	2.625	3.875	4.125
G	0.750	1.188	1.063	1.438
H	4.500	5.438	7.000	9.000
J	2.000	2.500	3.000	3.500
K	1.200	1.700	2.150	2.650
L	0.297	0.516	0.438	0.594
M	1.250	1.750	2.250	2.750
N	1.250	1.625	1.625	2.125
P	0.750	1.000	1.250	1.750
R	1.500	1.750	2.750	2.750
S	3.406	3.969	5.125	5.812
T	5.680	6.420	8.140	9.810
U	1.340	1.340	2.040	2.580
V	1.130	1.380	2.040	2.580
W	0.500	0.500	0.787	0.950
X	0.720	0.720	1.420	1.790

Motor Frame	12		16		24		32	
	17	23	23	23	34	23	34	
Y ∞	3.92	3.92	4.04	5.13	6.29	5.89	7.52	
Z ∞ 1:1	2.63	2.63	2.88	3.78	4.2	4.26	5.11	
Z ∞ 2:1	NA	NA	NA	3.75	4.17	4.28	5.08	
AA ∞	1.66	1.66	1.66	2.28	2.87	3.19	3.19	
BB ∞	NA	NA	NA	1.66	2.00	2.00	2.00	
CC ∞	1.66	2.00	2.25	2.35	3.75	3.00	3.75	
DD ∞	1.85	2.49	2.49	2.55	3.28	2.63	2.38	
EE ∞	2.26	2.26	2.26	2.50	3.79	2.58	4.25	

LMI Motor Mount

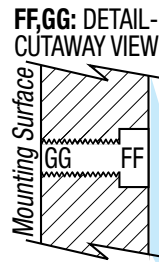
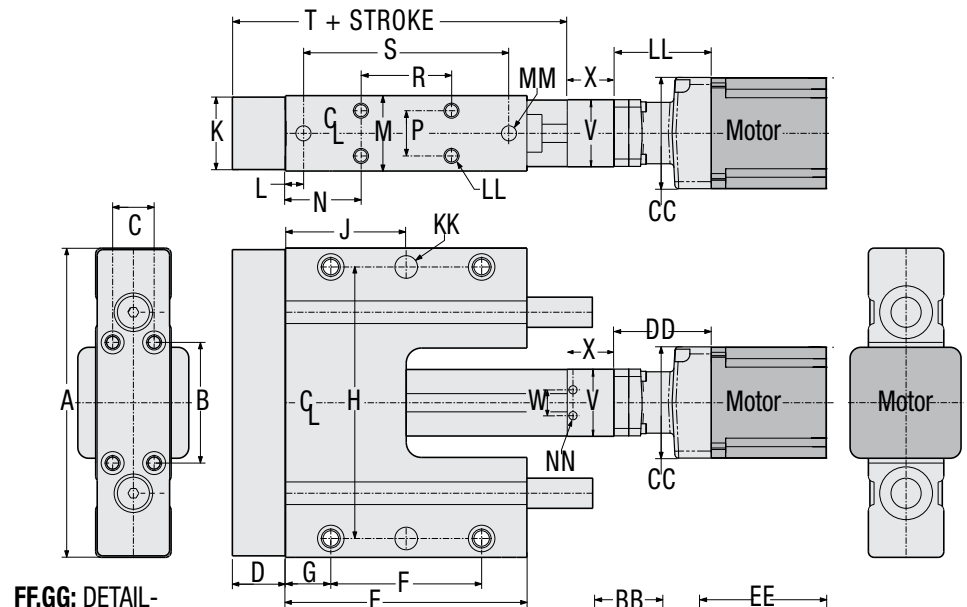

RP Motor Mount

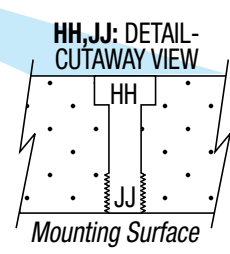
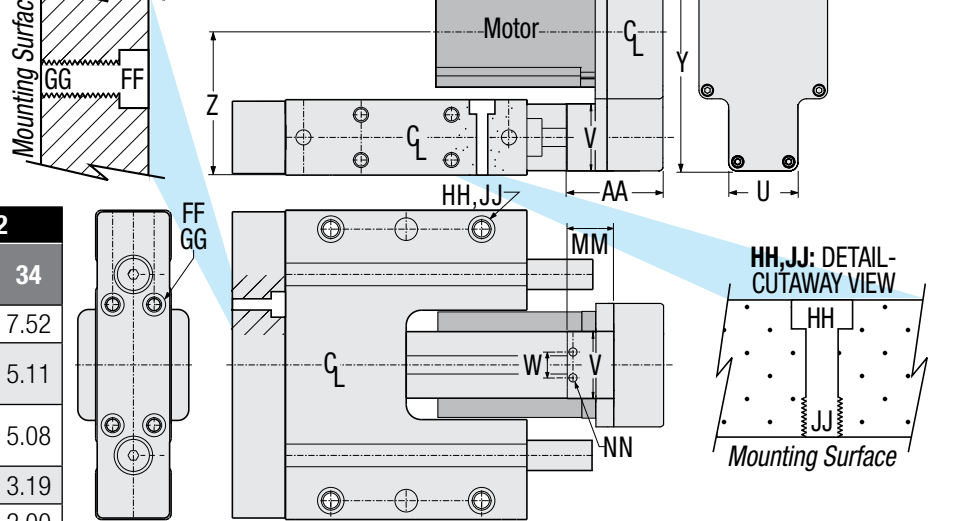

	12	16	24	32
FF [4X]	Ø0.206 THRU \perp Ø.38 I.22	Ø0.266 THRU \perp Ø.44 I.28	Ø0.266 THRU \perp Ø.44 I.28	Ø0.328 THRU \perp Ø.53 I.50
GG [4X]	1/4-20 THRU	5/16-18 THRU	5/16-18 THRU	3/8-16 THRU
HH[4X]	Ø.266 THRU \perp Ø.44 I0.28	Ø.266 THRU \perp Ø.44 I0.28	Ø.328 THRU \perp Ø.53 I0.34	Ø.453 THRU \perp Ø.72 I0.47
JJ [4X]	5/16-18 I0.75	5/16-18 I0.75	3/8-16 I1.00	1/2-13 I1.50
KK Ø [2x]	0.375 I0.500	0.375 I0.50	0.500 I0.50	0.500 I0.50
LL Ø [4x]	1/4-20 I0.50	1/4-20 I0.50	5/16-18 I0.63	3/8-16 I0.75
MM Ø [4x]	0.250 I0.38	0.250 I0.38	0.313 I0.50	0.375 I0.50
NN [2x]	8-32 I0.25	8-32 I0.25	1/4-20 I0.31	5/16-18 I0.50

GSA-ST GUIDED SCREW-DRIVE ACTUATOR

tolomatic.com/CAD Download 3D CAD Always use CAD solid model to determine critical dimensions



Metric Measurements

	12	16	24	32
A	130.20	158.80	196.90	254.00
B	50.80	63.50	88.90	127.00
C	17.46	25.40	34.93	44.45
D	22.40	28.60	35.10	41.40
E	101.60	127.00	152.40	177.80
F	63.50	66.68	98.43	104.78
G	19.05	30.18	27.00	36.51
H	114.30	138.13	177.80	228.60
J	50.80	63.50	76.20	88.90
K	30.50	43.20	54.60	67.30
L	7.54	13.11	11.13	15.09
M	31.80	44.50	57.20	69.90
N	31.75	41.28	41.28	53.98
P	19.05	25.40	31.75	44.45
R	38.10	44.45	69.85	69.85
S	86.51	100.81	130.18	147.62
T	144.10	163.10	206.60	249.00
U	34.10	34.10	51.80	65.50
V	28.60	35.00	51.80	65.50
W	12.70	12.70	20.00	24.13
X	18.30	18.30	36.00	45.40

LMI Motor Mount

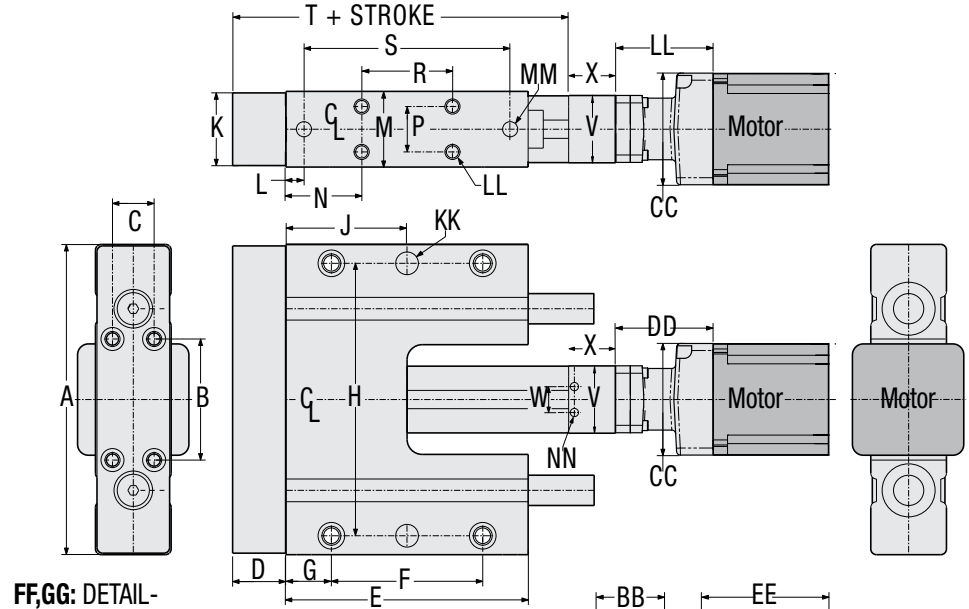

FF,GG: DETAIL-CUTAWAY VIEW

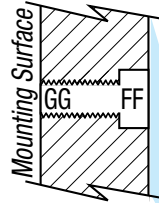

RP Motor Mount

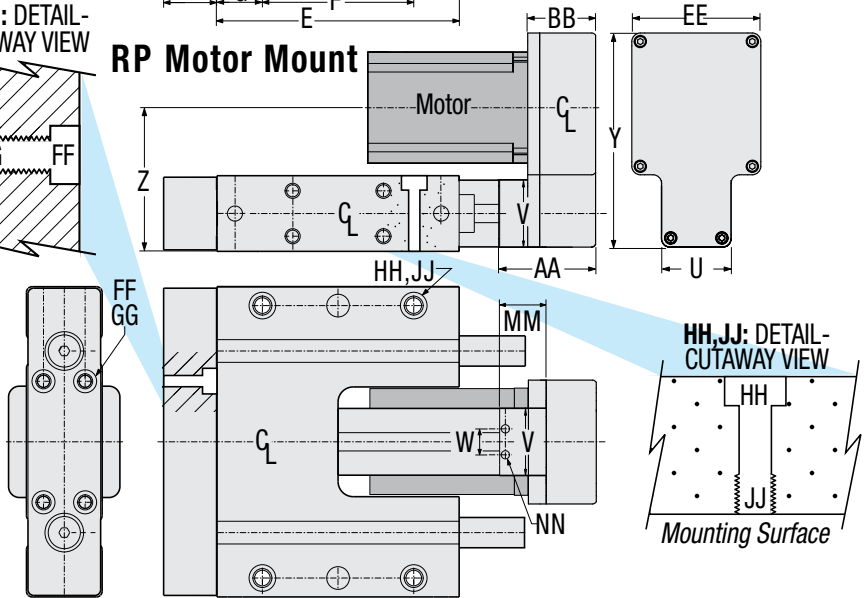

HH, JJ: DETAIL-CUTAWAY VIEW

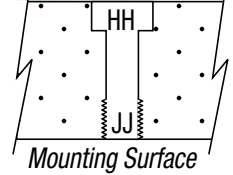

	12	16	24	32
Motor Frame	17	23	23	34
Y ∞	99.5	99.5	102.7	130.2
Z ∞ 1:1	66.9	66.9	73.2	96.1
Z ∞ 2:1	NA	NA	NA	95.3
AA ∞	42.1	42.1	42.1	57.9
BB ∞	NA	NA	NA	42.2
CC ∞	42.0	50.8	57.2	59.7
DD ∞	47.0	63.2	63.2	64.8
EE ∞	57.3	57.3	57.3	63.5

	12	16	24	32
FF [4x]	\varnothing 5.23 THRU \sqcup \varnothing 9.7 \downarrow 5.6	\varnothing 6.76 \sqcup \varnothing 11.1? \downarrow 7.1	\varnothing 6.76 \sqcup \varnothing 11.1? \downarrow 7.1	\varnothing 8.51 \sqcup \varnothing 13.5 \downarrow 12.7
GG [4x]	M6x1.0 THRU	M8x1.25 THRU	M8x1.25 THRU	M10x1.5 THRU
HH [4x]	\varnothing 6.76 THRU \sqcup \varnothing 11.1 \downarrow 7.1	\varnothing 6.76 THRU \sqcup \varnothing 11.1 \downarrow 7.1	\varnothing 8.33 THRU \sqcup \varnothing 13.5 \downarrow 8.6	\varnothing 10.49 THRU \sqcup \varnothing 18.2 \downarrow 11.9
JJ [4x]	M8x1.25 \downarrow 19.1	M8x1.25 \downarrow 19.1	M10x1.5 \downarrow 25.4	M12x1.75 \downarrow 38.1
KK \varnothing [2x]	10.00 \downarrow 12.70	10.00 \downarrow 12.70	12.00 \downarrow 12.70	12.00 \downarrow 12.70
LL \varnothing [4x]	M6x1.0 \downarrow 12.7	M6x1.0 \downarrow 12.7	M8x1.25 \downarrow 16.0	M10x1.5 \downarrow 19.1
MM \varnothing [4x]	6.00 \downarrow 9.5	6.00 \downarrow 9.5	8.00 \downarrow 9.5	10.00 \downarrow 12.7
NN [2x]	M4x0.7 \downarrow 6.3	M4x0.7 \downarrow 6.3	M6x1.0 \downarrow 8.6	M8x1.25 \downarrow 12.7

GSA-HT GUIDED SCREW-DRIVE ACTUATOR

tolomatic.com/CAD Download 3D CAD Always use CAD solid model to determine critical dimensions



US Conventional Measurements

	24HT		32HT	
	RN	RN	BN	BZ
A	7.75	10.00	10.00	10.00
B	2.25	2.75	2.75	2.75
C	3.50	5.00	5.00	5.00
D	1.38	1.75	1.75	1.75
E	1.58	1.97	1.97	1.97
F	6.30	7.87	7.87	7.87
G	1.38	1.63	1.63	1.63
H	0.13	0.13	0.13	0.13
J	6.00	7.00	7.00	7.00
K	1.06	1.44	1.44	1.44
L	3.88	4.13	4.13	4.13
M	7.00	9.00	9.00	9.00
N	2.00	2.50	2.50	2.50
P	2.04	3.25	2.58	2.58
R	3.39	3.25	3.25	3.25
S	1.53	2.38	1.81	1.81
T	0.79	0.95	0.95	0.95
U	1.63	2.13	2.13	2.13
V	2.75	2.75	2.75	2.75
W	1.25	1.75	1.75	1.75
X	0.44	0.59	0.59	0.59
Y	5.13	5.81	5.81	5.81
Z	2.25	3.50	1.79	1.79
AA	10.17	12.63	10.92	9.85
BB	7.92	9.13	9.13	8.06
CC	2.25	3.50	1.19	1.19
DD	10.17	12.63	10.33	9.25
EE	2.00	2.33	2.00	2.00
FF	1:1	4.18	5.31	4.92
	2:1	4.20	5.30	4.88
GG	---	0.25	---	---
HH	6.40	7.63	7.60	7.60
JJ	3.79	4.38	4.25	4.25

KK,LL,MM,NN: DETAIL-CUTAWAY VIEW

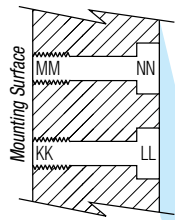

LMI MOUNT

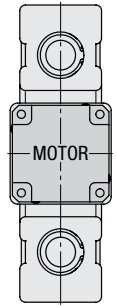
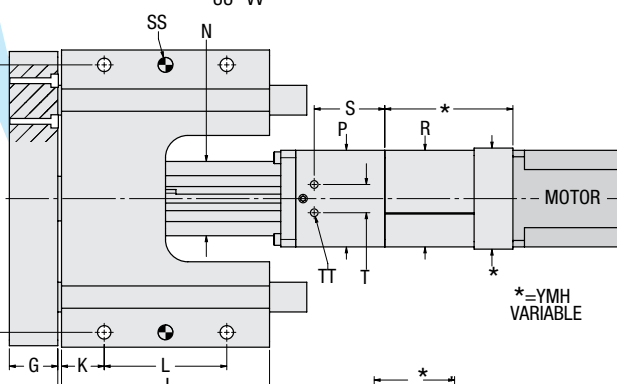
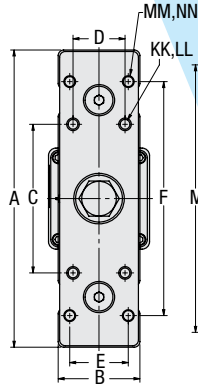
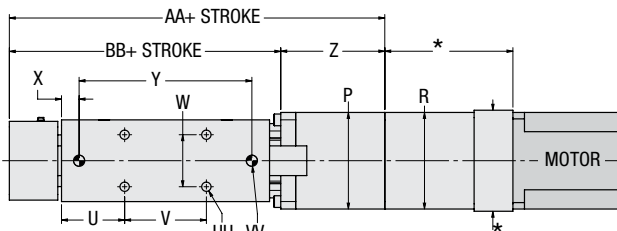

NOTE: GSA-HT Tooling plate has both US conventional (KK,LL) and metric (MM,NN) tapped holes

RP MOUNT

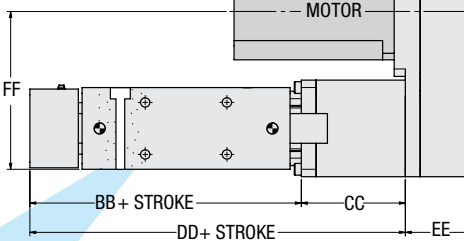

PP,RR: DETAIL-CUTAWAY VIEW

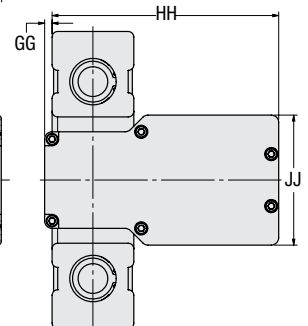
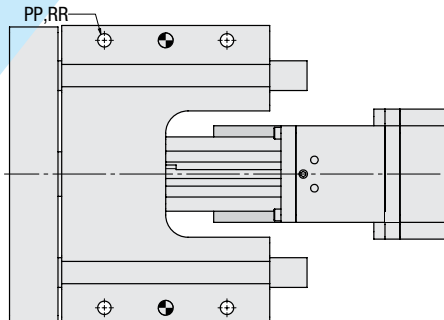
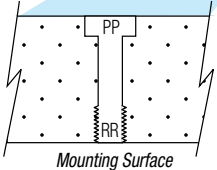

	24HT		32HT	
	RN	RN	BN	BZ
KK	5/16-18 THRU	3/8-16 THRU	3/8-16 THRU	3/8-16 THRU
LL	∅.266 THRU L∅.44 x I.28	∅.328 THRU L∅.53 x I.50	∅.328 THRU L∅.53 x I.50	∅.328 THRU L∅.53 x I.50
MM	M8x1.25 THRU	M10x1.5 THRU	M10x1.5 THRU	M10x1.5 THRU
NN	∅.266 THRU L∅.44 x I.28	∅.328 THRU L∅.53 x I.50	∅.328 THRU L∅.53 x I.50	∅.328 THRU L∅.53 x I.50
PP	∅.328 THRU L∅.53 x I.34	∅.453 THRU L∅.72 x I.47	∅.453 THRU L∅.72 x I.47	∅.453 THRU L∅.72 x I.47
RR	3/8-16 I1.00	1/2-13 I1.50	1/2-13 I1.50	1/2-13 I1.50
SS	∅.500/.501 x I0.50	∅.500/.501 x I0.50	∅.500/.501 x I0.50	∅.500/.501 x I0.50
TT	1/4-20 x I0.34	5/16-18 x I 0.50	5/16-18 x I0.50	5/16-18 x I0.50
UU	5/16-18 x I0.63	3/8-16 x I0.75	3/8-16 x I0.75	3/8-16 x I0.75
VV	∅.3125/.3135 x I0.50	∅.375/.376 x I0.50	∅.375/.376 x I0.50	∅.375/.376 x I0.50

GSA-HT GUIDED SCREW-DRIVE ACTUATOR

tolomatic.com/CAD Download 3D CAD Always use CAD solid model to determine critical dimensions



Metric Measurements

	24HT		32HT	
	RN	RN	BN	BZ
A	196.9	254.0	254.0	254.0
B	57.2	69.9	69.9	69.9
C	88.9	127.0	127.0	127.0
D	34.9	44.5	44.5	44.5
E	40.0	50.0	50.0	50.0
F	160.0	200.0	200.0	200.0
G	35.1	41.4	41.4	41.4
H	3.8	3.8	3.8	3.8
J	152.4	177.8	177.8	177.8
K	27.0	36.5	36.5	36.5
L	98.4	104.8	104.8	104.8
M	177.8	228.6	228.6	228.6
N	50.8	63.5	63.5	63.5
P	51.8	85.6	65.5	65.5
R	86.1	85.6	85.6	85.6
S	39.0	60.3	46.0	46.0
T	20.0	24.1	24.1	24.1
U	41.3	54.0	54.0	54.0
V	69.9	69.9	69.9	69.9
W	31.8	44.5	44.5	44.5
X	11.1	15.1	15.1	15.1
Y	130.2	147.6	147.6	147.6
Z	57.2	88.9	45.4	45.4
AA	258.4	320.9	277.4	250.2
BB	201.3	232.0	232.0	204.8
CC	57.2	88.9	30.3	30.3
DD	258.4	320.9	262.3	235.1
EE	50.7	59.16	50.7	50.7
FF	1:1 106.1	134.9	124.9	124.9
	2:1 106.6	134.5	124.0	124.0
GG	---	6.4	---	---
HH	162.4	193.7	193.0	193.0
JJ	96.3	111.1	108.0	108.0

KK,LL,MM,NN: DETAIL-CUTAWAY VIEW

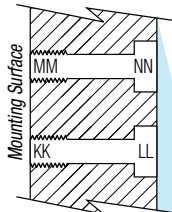

LMI MOUNT

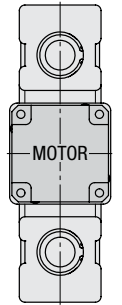
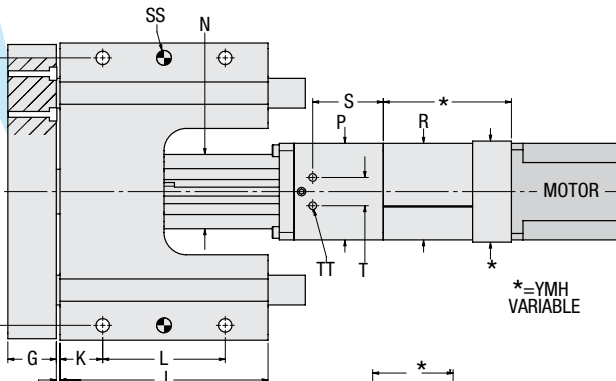
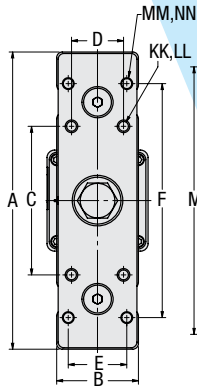
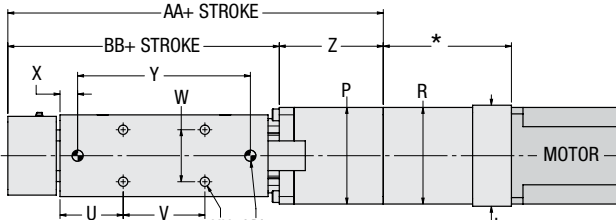

NOTE: GSA-HT Tooling plate has both US conventional (KK,LL) and metric (MM,NN) tapped holes

RP MOUNT

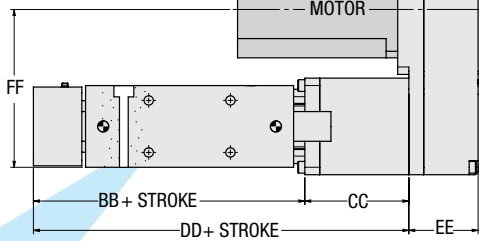

PP, RR: DETAIL-CUTAWAY VIEW

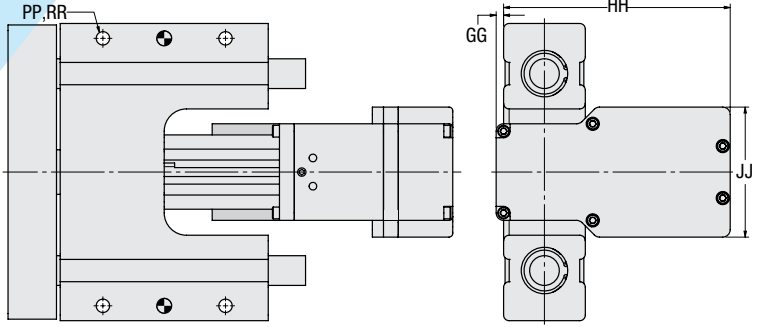
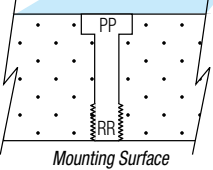

	24HT		32HT	
	RN	RN	BN	BZ
KK	5/16-18 THRU		3/8-16 THRU	
LL	Ø6.76 THRU ⊥Ø11.2 x Ⓡ7.1		Ø8.33 THRU ⊥Ø13.5 x Ⓡ12.7	
MM	M8x1.25 THRU		M10x1.5 THRU	
NN	Ø6.76 THRU ⊥Ø11.2 x Ⓡ7.1		Ø8.50 THRU ⊥Ø13.5 x Ⓡ12.7	
PP	Ø8.33 THRU ⊥Ø13.5 x Ⓡ8.6		Ø10.49 THRU ⊥Ø18.2 x Ⓡ11.9	
RR	M10x1.5 x Ⓡ25.4		M12x1.75 x Ⓡ38.1	
SS	Ø 12.00/12.03 x Ⓡ12.7		Ø 12.00/12.03 x Ⓡ12.7	
TT	M6X1.0 x Ⓡ9.0 D		M8X1.25 x Ⓡ12.0	
UU	M8X1.25 x Ⓡ16.0		M10X1.5 x Ⓡ19.1	
VV	Ø 7.99/8.01 x Ⓡ9.5		Ø 10.01/10.03 x Ⓡ12.7	



CK & CKS Stop Collars



Provides a positive stop mechanism when required.

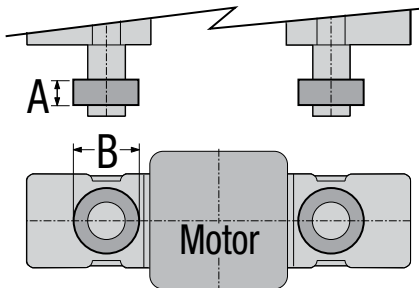

SIZE: **24, 32**

RE-LUBRICATION RECOMMENDATION:

RSA-HT Lubrication requirements for electric actuators depend on the motion cycle (velocity, force, duty cycle), type of application, ambient temperature, environmental surrounding and various other factors.

For many general purpose applications, Tolomatic ball screw actuators are typically considered lubricated for life unless otherwise specified, such as those actuator models outfitted with a re-lubrication feature. For roller screw or ball screw actuators outfitted with a re-lubrication feature, Tolomatic recommends to re-lubricate the actuator at least once per year or every 1,000,000 cycles, whichever comes first, to maximize service life. For more demanding applications such as pressing, high frequency or other highly stressed applications, the

STANDARD GUIDE RODS

Size	A	B Ø
12	0.406	1.125
16	0.438	1.313
24	0.500	1.500
32	0.500	1.750

Dimensions in inches

Size	A	B Ø
12	10.31	28.58
16	11.13	33.35
24	12.70	38.10
32	12.70	44.45

Dimensions in millimeters

OVERSIZED GUIDE RODS

Size	A	B Ø
12	0.438	1.313
16	0.500	1.500
24	0.500	1.750
32	0.500	2.063

Dimensions in inches

Size	A	B Ø
12	11.13	33.35
16	12.70	38.10
24	12.70	44.45
32	12.70	52.40

Dimensions in millimeters

re-lubrication interval for these actuators will vary and will need to be more frequent. In these demanding applications, it is recommended to execute at least 5 full stroke moves every 5,000 cycles of operation (or more frequent if possible) to re-distribute the grease within the actuator.

Re-lubricate with Tolomatic Grease into the grease zerk located on the rod end.

	GSA24	GSA32
Qty.	2.5g + (0.010 x § mm)	4.8g + (0.010 x § mm)
Qty.	0.09 oz + (0.009 x § in)	0.17 oz + (0.009 x § in)

§ = Stroke length (mm or in)

⚠ In some applications oil may leak from the grease zerk. In contamination sensitive applications replace grease zerk with plug.

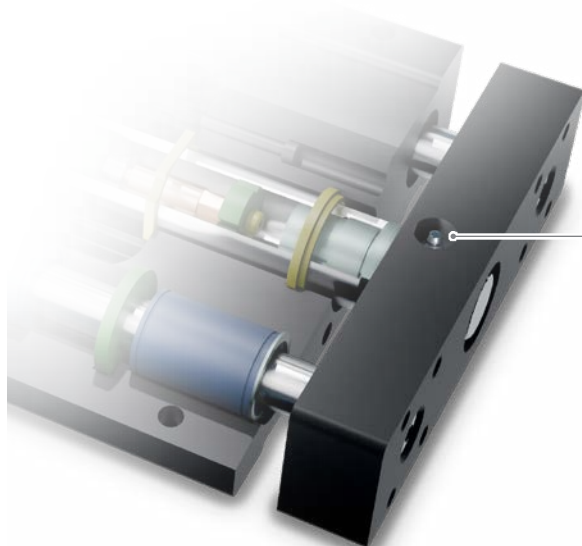

GREASE ZERK

- This relubrication system provides extended screw service life
- Convenient lubrication without disassembly
- Standard with all HT option GSA actuators
- Grease zerk orientation is not pre-defined. Custom orientation can be requested as a product modification





RSA & GSA products offer a wide range of sensing choices. There are 12 switch choices: reed, solid state PNP (sourcing) or solid state NPN (sinking); in normally open or normally closed; with flying leads or quick-disconnect.

Commonly used for end-of-stroke positioning, these switches allow installation anywhere along the entire actuator length. The internal magnet is a standard feature. Switches can be installed in the field at any time.

Switches are used to send digital signals to PLC (programmable logic controller), TTL, CMOS circuit or other controller device. Switches contain reverse polarity protection. Solid state QD cables are shielded; shield should be terminated at flying lead end.

All switches are CE rated and are RoHS compliant. Switches feature bright red or yellow LED signal indicators; solid state switches also have green LED power indicators.



	Order Code	Lead	Switching Logic	Power LED	Signal LED	Operating Voltage	**Power Rating (Watts)	Switching Current (mA max.)	Current Consumption	Voltage Drop	Leakage Current	Temp. Range	Shock / Vibration
REED	R Y	5m	SPST Normally Open	—	Red	5 - 240 AC/DC	**10.0	100mA	—	3.0 V max.	—	14 to 158°F [-10 to 70°C]	50 G / 9 G
	R K	QD*											
	N Y	5m	SPST Normally Closed	—	Yellow	5 - 110 AC/DC							
	N K	QD*											
SOLID STATE	T Y	5m	PNP (Sourcing) Normally Open	Green	Yellow	10 - 30 VDC	**3.0	100mA	20 mA @ 24V	2.0 V max.	0.05 mA max.		
	T K	QD*											
	K Y	5m	NPN (Sinking) Normally Open	Green	Red								
	K K	QD*											
	P Y	5m	PNP (Sourcing) Normally Closed	Green	Yellow								
	P K	QD*											
	H Y	5m	NPN (Sinking) Normally Closed	Green	Red								
	H K	QD*											

*QD = Quick-disconnect Enclosure classification IEC 529 IP67 (NEMA 6)

CABLES: Robotic grade, oil resistant polyurethane jacket, PVC insulation

⚠️ **WARNING: Do not exceed power rating (Watt = Voltage x Amperage). Permanent damage to sensor will occur.

SWITCH INSTALLATION



Place switch bracket into one of the four slots that run the length of the extruded tube. Note that there is a cutout on the actuator head (RSA) or tube (GSA) to allow insertion of the bracket. Insert the switch with the word "Tolomatic" facing up and slide it under the bracket. Position the bracket with the switch to the exact location desired, then lock them securely into place by tightening both set screws on the bracket.

GSA GUIDED SCREW-DRIVE ACTUATOR

WIRING DIAGRAMS

SWITCHES

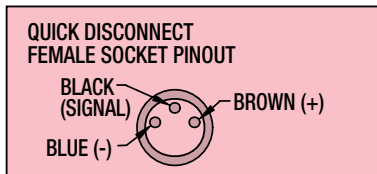
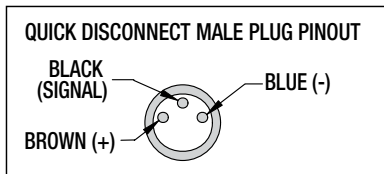
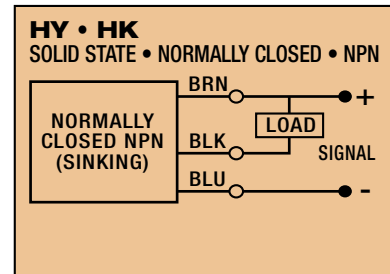
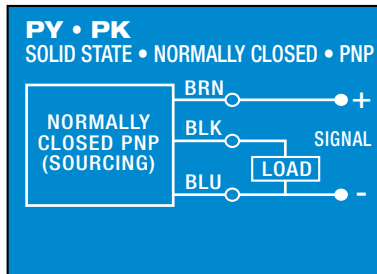
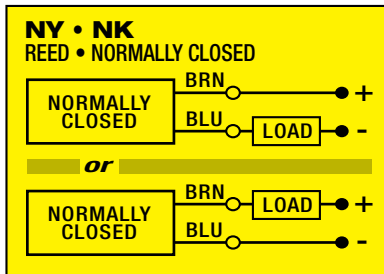
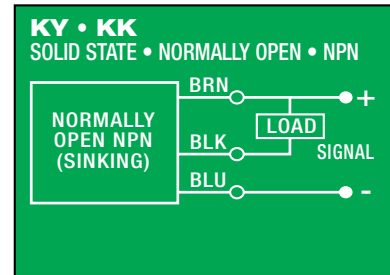
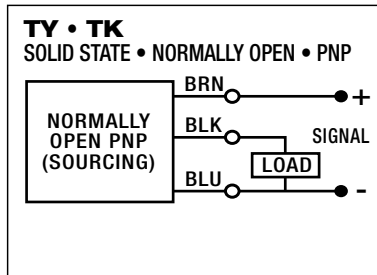
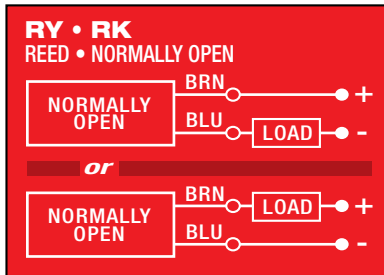

SWITCH DIMENSIONS

_Y - direct connect

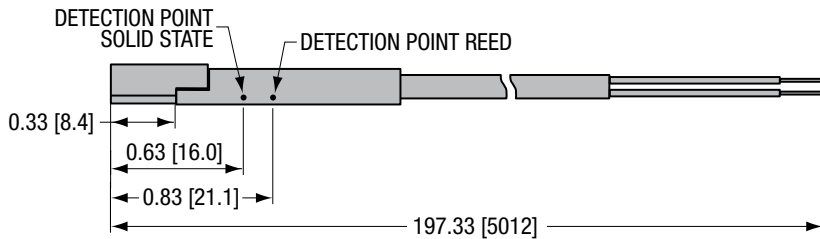

_K - QD (Quick-disconnect) switch

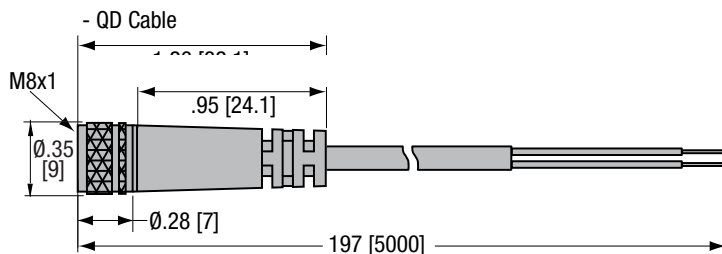
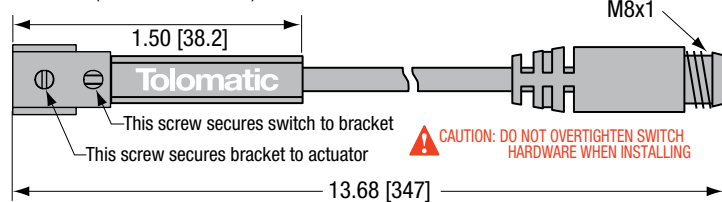

Dimensions shown in inches [dimensions in brackets millimeters]

MOUNTING DIMENSIONS

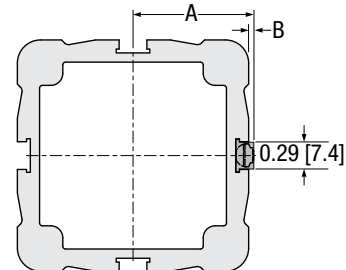

Size	A		B	
	in	mm	in	mm
12	0.68	17.2	0.13	3.3
16	0.77	19.6	0.11	2.9
24	1.06	26.9	0.06	1.5
32	1.31	33.2		
50	1.87	47.5		
64	2.31	58.6		

Application Data Worksheet

USE THE TOLONATIC SIZING AND SELECTION SOFTWARE AVAILABLE ON-LINE AT www.tolomatic.com
or call Tolomatic at 1-800-328-2174. We will provide any assistance needed to determine the proper actuator for the job.

ACTUATOR ORIENTATION

- Horizontal Vertical-Motor End Up Angled Vertical-Motor End Down

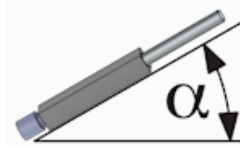

Angle: _____ degrees

ACTUATOR REQUIREMENTS

- Stroke Length: _____ inches millimeters
 No. of Cycles: _____ per minute per hour
 Actuator to Hold Position: required not required
 If Hold Required: after move during power loss
 Motor: Third Party Motor Tolomatic Motor

ACTUATOR ENVIRONMENT

- Ambient Temperature: _____ °F °C
 Actuator Environment Description and Ingress Protection Requirements:

MOTION & FORCES

Extend

- Move Distance: _____ in mm
 Move Time: _____ seconds
 Max. Speed: _____ in/s mm/s
 Dwell Time After Move: _____ seconds

Load

- Load: _____ lb kg
 Supported by Actuator: _____ %
 Moment Prevention: Guided/Supported
 Center of Load:
 Dx: _____ in mm
 Dy: _____ in mm
 Dz: _____ in mm
 Assign to Moves: Extend Retract

Retract

- Move Distance: _____ in mm
 Move Time: _____ seconds
 Max. Speed: _____ in/s mm/s
 Dwell Time After Move: _____ seconds

Force

- Force: _____ lbr N
 Force Direction: Toward Away
 Direction of Applied Force: F_x F_y F_z
 Center of Applied Force:
 Dx: _____ in mm
 Dy: _____ in mm
 Dz: _____ in mm
 Assign to Moves: Extend Retract

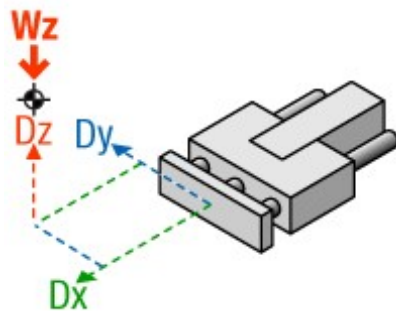

tolomatic.com/ask
Technical support
before and after
purchase

sizeit.tolomatic.com
for fast, accurate
actuator selection

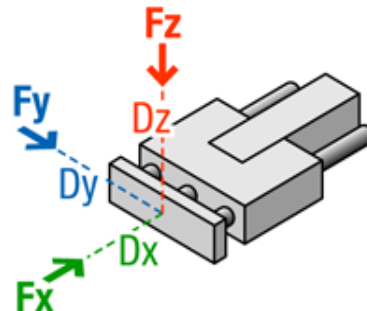

GSA GUIDED SCREW-DRIVE ACTUATOR

Selection Guidelines

1 ESTABLISH MOTION PROFILE

Using the application stroke length, desired cycle time, loads and forces, establish the motion profile details including linear velocity and thrust in each of its segments.

2 SELECT ACTUATOR TYPE

If side (radial) loads are present, select GSA.

3 SELECT ACTUATOR SIZE AND SCREW TYPE

Based on the required velocities and thrust select an actuator size and type and lead of screw drive.

4 VERIFY CRITICAL SPEED OF THE SCREW

Verify that the application's peak linear velocity does not exceed the critical speed value for the size and lead of the screw selected.

5 VERIFY AXIAL BUCKLING STRENGTH OF THE SCREW

Verify that the peak thrust does not exceed the critical buckling force for the size of the screw selected.

6 COMPARE APPLICATION'S PEAK PARAMETERS TO PEAK CAPACITY (PEAK REGION) OF SELECTED ACTUATOR (ROLLER SCREW)

When a roller screw is selected, calculate the application's required peak thrust and peak velocity and compare to the graphs. The selection must satisfy the application's peak requirements.

7 CALCULATE LUBRICATION INTERVAL (ROLLER SCREW)

When a roller screw is selected, calculate the recommended lubrication interval. See page R/GSA_33 and parts sheets for complete lubrication information for the RSA24, RSA32, RSA50 and RSA64 HT option.

8 TEMPERATURE CONSIDERATIONS

If the application's ambient temperature lies outside of the allowed range [roller screw: 50° to 122°F (10° to 50°C), all others 40° to 130°F (4° to 54°C), contact the factory. Note that in aggressive applications where roller screw is used, outside temperature of the actuator's body can approach 180°F (82°C), and adequate clearance to avoid overheating of other system components should be allowed.

9 ESTABLISH TOTAL TORQUE REQUIREMENTS

Calculate total system inertia, the peak and the RMS torque required from the motor to overcome internal friction, external forces and accelerate/decelerate the load.

10 SELECT A MOTOR AND A CONTROLLER

Use the obtained total torque value to select a motor and a reduction device (if required). Verify that the peak torque value is below the motor's peak torque curve, and that the continuous torque value is below the motor's continuous torque curve. Verify the minimum torque margin (15%). Verify the inertia match. Select a controller.

11 SELECT A MOTOR-ACTUATOR CONFIGURATION AND SENSORS IF REQUIRED

Select an inline or a reverse-parallel motor configuration. Select mounting and rod end options. Select position sensors (if required). 12 sensor choices include: reed, solid state PNP or NPN, all in normally open or normally closed, with flying leads or quick-disconnect couplers.

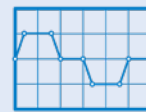

sizeit.tolomatic.com
for fast, accurate
actuator selection



tolomatic.com/ask
Technical support
before and after
purchase



The above guidelines are for reference only.
Use Tolomatic online sizing software for best results.

GSA OPTIONS REPLACEMENT KITS

Description	SIZE			
	12	16	24	32
Stop Collar	2312-1005	2317-1005	2334-1005	2332-1005
Stainless Steel Stop Collar	2312-1056	2317-1056	2324-1056	2332-1056

Description	SIZE			
	12	16	24	32
Over-Sized Stop Collar	2317-1005	2324-1005	2332-1005	2348-1005
Stainless Steel Over-Sized Stop Collar	2317-1056	2324-1056	2332-1056	2348-1056

 Kits include one collar and required fasteners

RSA & GSA SWITCHES

To order switch kit use configuration code for switch preceded by SW and actuator code.



The example is for Solid State NPN, Normally Open Switch with Quick-disconnect couplers. Each switch kit is complete with Bracket, Set Screw, Switch and mating QD cable. Note that the bracket/switch size is common and may be used on any size GSA.

 **NOTE:** Refer to parts sheets to replace switches on actuators manufactured before 5-10-2010.

Reverse-Parallel Tensioning Tool Kit	24ST	24HT / 32 all
order by part number	1124-9430	1132-9430

Code	Lead	Normally	Sensor Type
R Y	5m (197 in)	Open	Reed
R K	Quick-disconnect		
N Y	5m (197 in)	Closed	Reed
N K	Quick-disconnect		
T Y	5m (197 in)	Open	Solid State PNP
T K	Quick-disconnect		
K Y	5m (197 in)	Open	Solid State NPN
K K	Quick-disconnect		
P Y	5m (197 in)	Closed	Solid State PNP
P K	Quick-disconnect		
H Y	5m (197 in)	Closed	Solid State NPN
H K	Quick-disconnect		

GSA GUIDED SCREW-DRIVE ACTUATOR

ORDERING

ACTUATOR GSA 24 BNL02 SK23 **OPTIONS** RPI ST1 CBSO CKS KK2 YM

MODEL & MOUNTING
GSA Guided Screw-Drive Actuator

SIZE
12, 16, 24, 32

NUT/SCREW COMBINATIONS

SIZE	CODE	CODE NUMBER
12	SN	01,02,05
	BZ	10
	BN, BNL	08
16	SN	01,02,05
	BZ	10
	BN, BNL	08
24	BZ	10
	BN, BNL	02,05
	BNM	05,10
32	BZ	10
	BN, BNL	02,05
	BNM	05,10,20
	RN	04,05,10

STROKE LENGTH

SK ___ Enter desired stroke length in decimal inches

SM † ___ (Metric Mounting) Enter desired stroke length in millimeters

NOTE: Actuator mounting threads and mounting fasteners will be either inch or metric, depending on how stroke length is indicated **SK**=inch mounting
SM= metric mounting

SIZE	MAXIMUM STROKE GSA	
	in	mm
12	18	457.2
16	24	609.6
24	30	762.0
32	36	914.4

† The metric version provides metric tapped tooling plate, actuator mounting and dowel pins

Not all codes listed are compatible with all options. Contact Tolomatic with any questions.

MOTOR MOUNTING

LMI In-line motor mount
RP1 1:1 ratio, reverse parallel motor mount
RP2 2:1 ratio, reverse parallel motor mount
✗ RP2 not available on 12 or 16 size

STANDARD OR HIGH TORQUE

ST1 Standard Torque
HT1* High Torque Option
*requires keyed motor
✗ HT1 not available on 12 or 16 size
NOTE: RN always requires HT1 option

BEARINGS & GUIDE RODS (GSA ONLY)

LB Linear Bearings*
CB Composite Bearings, Standard Size Rods
COB Composite Bearings, Over Sized Rods
CBS Composite Bearings, Standard Size Stainless Steel Rods
CBSO Composite Bearings, Over-Sized Stainless Steel Rods
✗ *Stainless steel guide rods not available with Linear Bearings

STOP COLLAR (GSA ONLY)

CK Steel Stop Collar
CKS Stainless Steel Stop Collar
NOTE: The correct Stop Collar will be automatically chosen based on the bearing and guide rod previously selected.



SWITCHES

TYPE	LOGIC	NORMALLY	QUICK-DISCONNECT	CODE	QUANTITY	LEAD LENGTH
REED	SPST	Open	no	RY	After code enter quantity desired	5 meters (16.4 feet)
		yes	yes	RK		
SOLID STATE	PNP	Open	no	TY		
		yes	yes	TK		
NPN	Open	no	yes	KY		
	yes	yes	yes	KK		
PNP	Closed	no	yes	PY		
		yes	yes	PK		
NPN	Closed	no	yes	HY		
		yes	yes	HK		

YOUR MOTOR HERE

YM _____ Motor mount for non-Tolomatic motor.
www.tolomatic.com

Brakes mounted on reverse parallel motor mounts (especially in vertically positioned actuators) will not prevent back driving of the screw and the load falling under gravity in the event of a timing belt failure. An inline motor mount with a fail-safe brake mounted directly to the actuator shaft or a special geared or thru-shaft reverse parallel construction should be considered if a brake is required in a safety critical application. Contact Tolomatic for alternate reverse parallel brake mounting options.

Gearheads may be used with RSA ST or GSA ST reverse parallel motor mounts. However, the torque on the belt and internal ST RP components must remain below the capabilities of the assembly to prevent belt slipping or premature failure. Contact Tolomatic for additional information if required.

FOOD GRADE LUBRICATION
LUB Grease, Food/Drug

The Tolomatic Difference Expect More From the Industry Leader:



INNOVATIVE PRODUCTS

Solutions with Endurance TechnologySM for challenging applications.



FAST DELIVERY

Built-to-order with configurable stroke lengths and flexible mounting options.

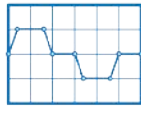

ACTUATOR SIZING

Size and select electric actuators with our online software.



YOUR MOTOR HERE[®]

Match your motor to compatible mounting plates with Tolomatic actuators.



CAD LIBRARY

Download 2D or 3D CAD files for Tolomatic products.



TECHNICAL SUPPORT

Get a question answered or request a virtual design consultation with one of our engineers.

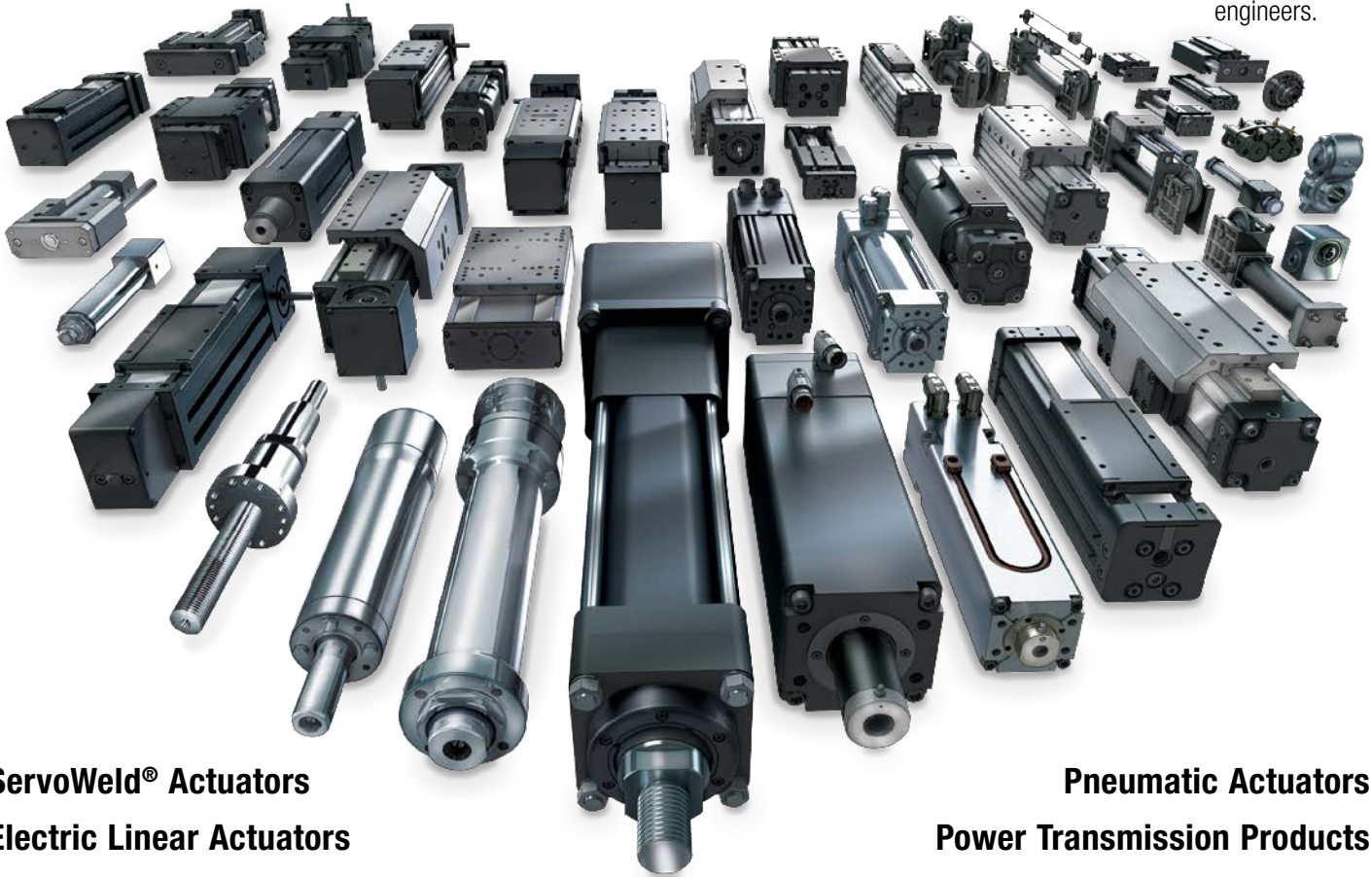

ServoWeld[®] Actuators
Electric Linear Actuators

Pneumatic Actuators
Power Transmission Products



MADE IN U.S.A.

TolomaticTM

EXCELLENCE IN MOTION

COMPANY WITH
QUALITY SYSTEM
CERTIFIED BY DNV
= ISO 9001 =
Certified site: Hamel, MN

USA - Headquarters

Tolomatic Inc.
3800 County Road 116
Hamel, MN 55340, USA
Phone: (763) 478-8000
Toll-Free: **1-800-328-2174**
sales@tolomatic.com
www.tolomatic.com

MEXICO

Centro de Servicio
Parque Tecnológico Innovación
Int. 23, Lateral Estatal 431,
Santiago de Querétaro,
El Marqués, México, C.P. 76246
Phone: +1 (763) 478-8000
help@tolomatic.com

EUROPE

Tolomatic Europe GmbH
Elisabethenstr. 20
65428 Rüsselsheim
Germany
Phone: +49 6142 17604-0
help@tolomatic.eu
www.tolomatic.com/de-de

CHINA

Tolomatic Automation Products (Suzhou) Co. Ltd.
No. 60 Chuangye Street, Building 2
Huqiu District, SND Suzhou
Jiangsu 215011 - P.R. China
Phone: +86 (512) 6750-8506
Tolomatic_China@tolomatic.com

All brand and product names are trademarks or registered trademarks of their respective owners. Information in this document is believed accurate at time of printing. However, Tolomatic assumes no responsibility for its use or for any errors

that may appear in this document. Tolomatic reserves the right to change the design or operation of the equipment described herein and any associated motion products without notice. Information in this document is subject to change without notice.

Visit www.tolomatic.com for the most up-to-date technical information