



A COMPARISON OF TOLOMATIC BELT DRIVE ACTUATORS

MXB-U Electric Belt Drive	MXB-P Electric Belt Drive	B3W Electric Belt Drive
		
<p><i>For complete information see www.tolomatic.com or literature number:</i></p>		
8500-4000	8500-4000	3600-4148
<ul style="list-style-type: none"> • High linear velocity 		
<ul style="list-style-type: none"> • High acceleration rates 		
<ul style="list-style-type: none"> • Long stroke lengths 		
<ul style="list-style-type: none"> • Excellent repeatability 		
<ul style="list-style-type: none"> • High duty cycles 		
<ul style="list-style-type: none"> • Low profile 		
<ul style="list-style-type: none"> • Requires external guidance and support 	<ul style="list-style-type: none"> • High load and bending moment capacities 	
<ul style="list-style-type: none"> • High precision bearings feature smooth, low breakaway motion 		
<ul style="list-style-type: none"> • Durable profiled rail design uses THK® Caged Ball® technology to reduce friction and extend actuator life 		

COMPARISON OF TOLOMATIC BELT DRIVE ACTUATORS

MXB32



The MXB electric actuator is exactly what you expect from the industry's number one rodless supplier. Designed with our exclusive ENDURANCE TECHNOLOGYSM features, the MX delivers superior performance to meet the most demanding applications. The MXB broadens the choices for belt drive actuators providing Tolomatic reliability in applications that were not available before. Nobody knows rodless like Tolomatic, and the MX proves it.

Use these graphs for a quick reference comparing the performance features of the MXB to the Tolomatic B3W. For complete information about the B3W visit our web site or check out the B3W brochure and the Electric products catalog.

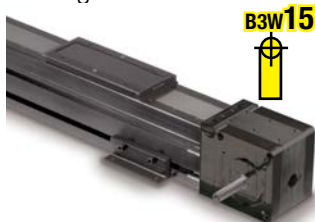

B3W Electric Belt Drive
(See #3600-4148 for complete information)

MAXIMUM SPEED COMPARISON

MXB 150 in/sec
B3W 200 in/sec

MAXIMUM THRUST COMPARISON

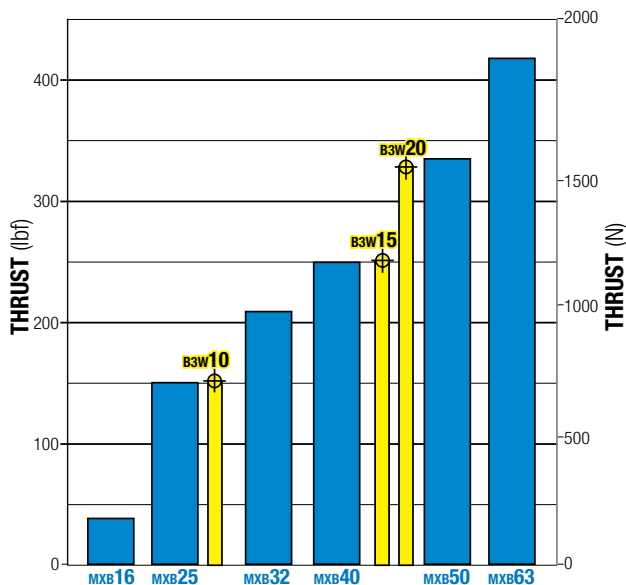

MOTOR MOUNTING

The MXB is unique among Tolomatic belt drive actuators. The mounting surface of the carrier is located 90° from the motion of the belt. The side opposite the belt is reserved for switch placement. The bottom of the actuator is reserved for mounting. If the motor is mounted in the SDT direct drive top orientation be sure the load mounted to the carrier does not interfere with the motor.

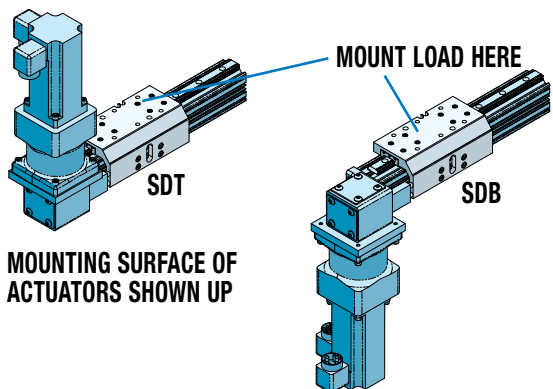

BENDING MOMENT COMPARISON

Mx

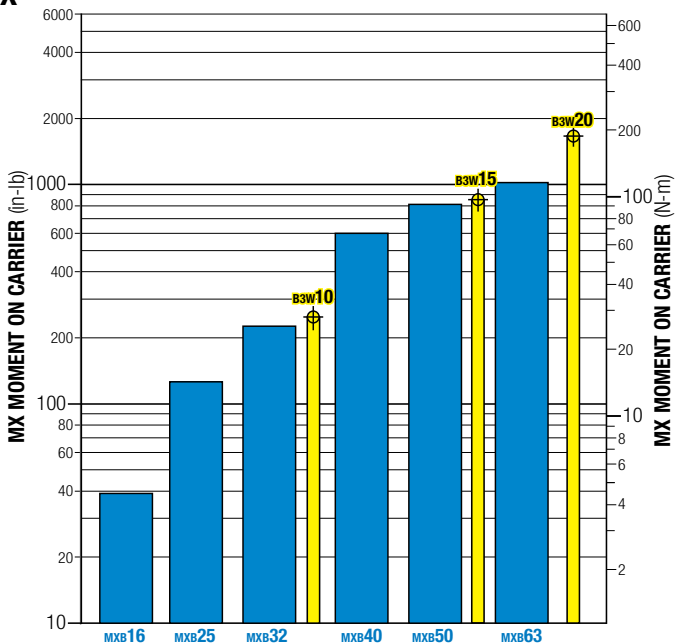

INERTIA COMPARISON

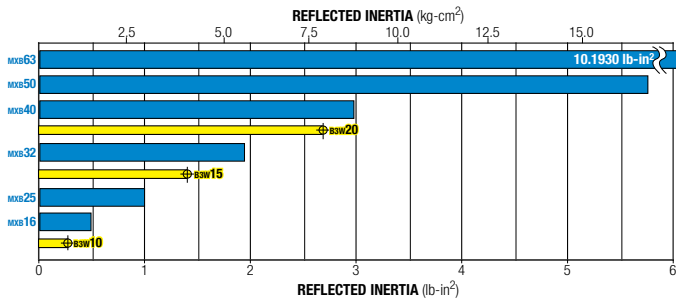

INERTIA PER UNIT OF STROKE COMPARISON

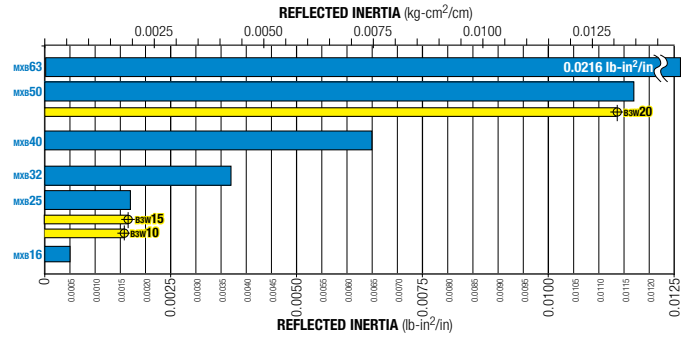

MAXIMUM STROKE LENGTH COMPARISON

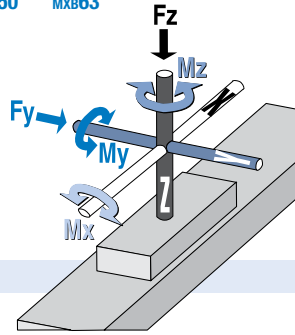
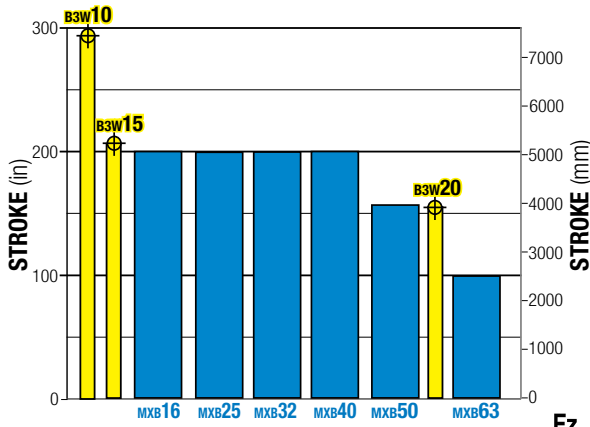

MAXIMUM LOAD Fy & Fz COMPARISON

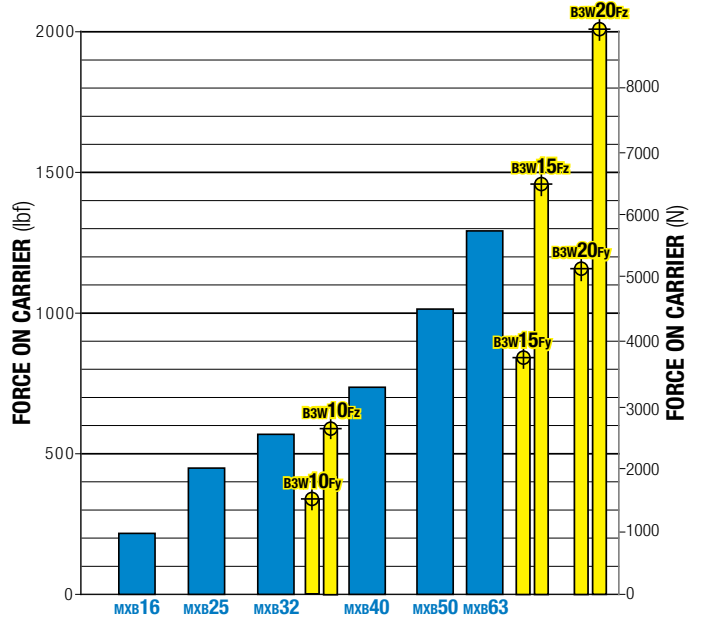

BENDING MOMENT COMPARISON

My

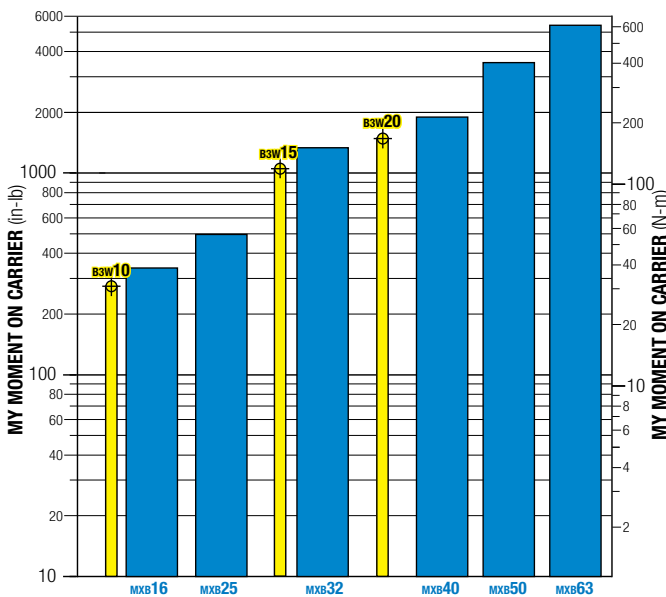

Mz

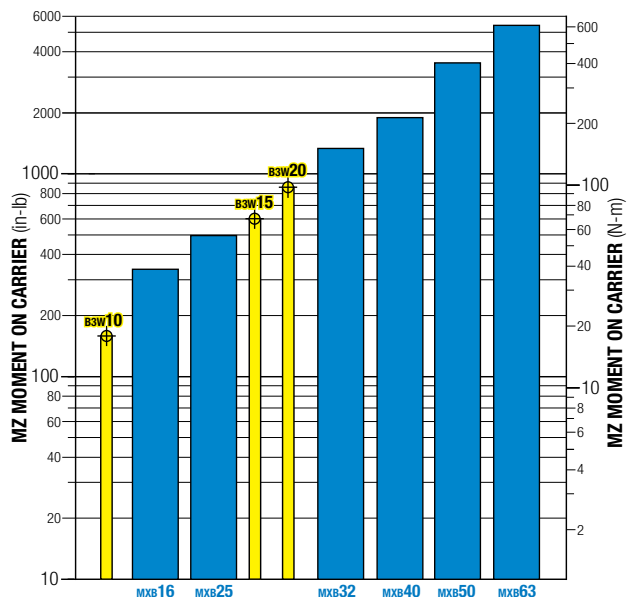



MXB-P

COMPARISON OF MXB AND B3W

The MXB and the B3W have many similarities, yet each have unique capabilities that suit different applications.

Note the actuators that use the same belt and pulley:

MXB25 = B3W10

MXB40 = B3W15

MXB50 = B3W20

This results in the same thrust.



B3W

FEATURE	MXB25	B3W10	MXB40	B3W15	MXB50	B3W20
Belt Width (in)	0.71		1.18		1.57	
Pulley Dia (in)	1.003		1.504		1.754	
Stroke per Rev (in)	3.151		4.725		5.501	
Thrust (lbf)	150		250		325	
Breakaway Torque (lb-in)	5.00	9.38	10.00	12.50	15.00	28.13
Max Stroke (in)	200	207	200	204	160	108
Dead Length (in)	12.34	12.46	16.12	16.54	16.92	17.00
LOAD						
Fy (lbf)	449	341	736	840	1014	1159
Fz (lbf)	449	591	736	1454	1014	2008
MOMENT						
Mx (in-lbs)	126	250	600	859	811	1662
My (in-lbs)	502	269	1913	1033	3483	1472
Mz (in-lbs)	502	156	1913	596	3483	850
SPEED						
	*MXB-P (200 in/sec for MXB-U)					
Max Velocity (in/sec)	150*	200	150*	200	150*	200
Max Acceleration (in/sec ²)	1,200	1,200	1,200	1,200	1,200	1,200
WEIGHT						
Base Unit (zero stroke) (lb)	4.36	7.54	14.07	25.12	20.84	35.40
per inch of Stroke (lb/in)	0.195	0.389	0.537	0.395	0.749	0.716
INERTIA						
Pulleys (lb-in ²)	0.0259	0.0259	0.3719	0.3719	0.7243	0.7243
Carrier (lb-in ²)	0.9914	0.1041	2.9693	0.5089	5.7498	0.9728
per inch of Stroke (lb-in ²)	0.0017	0.0016	0.0065	0.0017	0.0117	0.0114
Repeatability (in)	+/- .002	+/- .002	+/- .002	+/- .002	+/- .002	+/- .002
Straightness, Flatness (in)	.00067 L**	.00067 L**	.00067 L**	.00067 L**	.00067 L**	.00067 L**
IP Rating	—	44	—	44	—	44
Temp Range (°F)	10-130	40-130	10-130	40-130	10-130	40-130
Available Mounting Surfaces	1	3	1	3	1	3
Available Slots for Switches	1	2	1	2	1	2
Price at 48" Stroke (as % of B3W20 price)	50%	69%	68%	79%	86%	100%

**L = maximum distance between support plates (see lit. #3600-4609 or www.tolomatic.com)

Tolomatic™

3800 County Road 116, Hamel, MN 55340

http://www.Tolomatic.com • Email: Help@Tolomatic.com

Phone: (763) 478-8000 • Fax: (763) 478-8080 • Toll Free: 1-800-328-2174

**COMPANY WITH
QUALITY SYSTEM
CERTIFIED BY DNV
= ISO 9001 =**

Certified site: Hamel, MN

Information furnished is believed to be accurate and reliable. However, Tolomatic assumes no responsibility for its use or for any errors that may appear in this document. Tolomatic reserves the right to change the design or operation of the equipment described herein and any associated motion products without notice. Information in this document is subject to change without notice.