

# MANUAL

FOR INSTALLATION, MAINTENANCE  
AND OPERATION

## ServoWeld<sup>™</sup> Actuators CSW & CSW~~X~~ Models

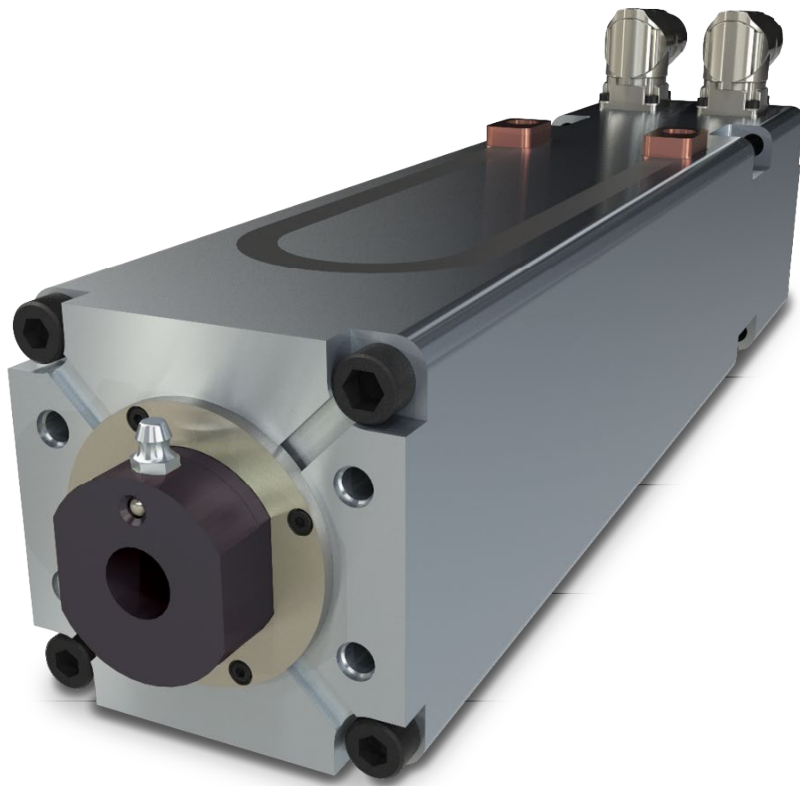

Tolomatic reserves the right to change the design or operation of the equipment described herein and any associated motion products without notice. Information in this document is subject to change without notice.

Copyright © 2024 Tolomatic, Inc. All rights Reserved.

All brand and product names are trademarks of their respective owners. Information in this document is believed to be accurate at time of publication.

Original Instructions - English

Translations will be supplied in other community languages as required by customers

## Table of Contents

• LIST OF TABLES AND FIGURES: .....	6
• <b>1.0 SAFETY</b> .....	<b>7</b>
• <b>1.1 SAFETY SYMBOLS</b> .....	<b>7</b>
• GENERAL .....	7
• SAFETY SYMBOLS .....	7
WARNING FOR HOT SURFACES.....	7
• <b>1.2 SAFETY CONSIDERATIONS</b> .....	<b>8</b>
• PROPER AND SAFE USE OF PRODUCT.....	8
• FAIL SAFE E-STOP RECOMMENDATIONS .....	8
• DEVICE DAMAGE PREVENTION .....	8
• PERSONAL SAFETY .....	8
• HANDLING AND UNPACKING .....	8
• PACKING AND TRANSPORT .....	8
• MODIFICATIONS TO THE EQUIPMENT .....	9
• REPAIR AND MAINTENANCE .....	9
• REQUIREMENT REGARDING PERSONNEL.....	9
• RISK AREA AND PERSONNEL.....	9
• <b>2.0 CSW &amp; CSWX SERVOWELD™ PRODUCT OVERVIEW:</b> .....	<b>10</b>
• 2.1 GENERAL DESCRIPTION .....	10
• <b>2.2 INTENDED USE</b> .....	<b>10</b>
• <b>2.3 STORAGE</b> .....	<b>11</b>
• <b>2.4 IDENTIFICATION LABEL</b> .....	<b>11</b>
• <b>2.5 CERTIFICATION</b> .....	<b>12</b>
• <b>2.6 MANUFACTURER</b> .....	<b>12</b>
• <b>3.0 CSW &amp; CSWX SERVOWELD™ CONFIGURATION OVERVIEW</b> .....	<b>13</b>
• <b>3.1 CSW, CSWX SERIES CONFIGURATION</b> .....	<b>13</b>
• <b>3.2 STANDARD CONFIGURATIONS AND OPTIONS</b> .....	<b>13</b>
• 3.2.1 INTERNAL ANTI-ROTATION OPTION .....	15
• 3.2.2 SCREW SELECTION .....	15
• 3.2.3 MOTOR VOLTAGE .....	15
• 3.2.4 WATER COOLING OPTION.....	15
• 3.2.5 MOUNTING OPTIONS .....	15
• 3.2.6 ROD END.....	15
• 3.2.7 INTERNAL HOLDING BRAKE OPTION.....	15
• 3.2.8 FEEDBACK DEVICE .....	15
• 3.2.9 CONNECTOR(S) .....	15
• 3.2.10 SERVO DRIVE .....	15
• <b>4.0 CSW &amp; CSWX SERVOWELD™ MECHANICAL INSTALLATION</b> .....	<b>16</b>
• <b>4.1 SERVOWELD™ ACTUATOR SYSTEM CONFIGURATION</b> .....	<b>16</b>
• <b>4.2 ACTUATOR OPERATION</b> .....	<b>16</b>

•	GENERAL OPERATION .....	16
•	COLD TEMPERATURE STARTUP PROCEDURE .....	17
•	TIP DRESS PROCEDURE .....	17
•	<b>4.3 PLANNING YOUR INSTALLATION .....</b>	<b>18</b>
•	INSTALLING THE SERVOWELD™ WELD ACTUATOR .....	18
•	SIDE LOAD CONSIDERATIONS.....	18
•	THRUST ROD WIPER/SCRAPER .....	19
•	CABLES .....	19
•	RSW SERVO SYSTEM CALIBRATION .....	19
•	WELD TIP / PART CONTACT SPEED .....	19
•	ROBOT CARRIED APPLICATIONS .....	19
•	TOOL CHANGER APPLICATIONS .....	19
•	FIXED/PEDESTAL APPLICATIONS.....	19
•	<b>4.4 MOUNTING.....</b>	<b>20</b>
•	THRUST ROD ATTACHMENT - ROUND THRUST ROD .....	20
•	THRUST ROD ATTACHMENT – DOUBLE FLAT THRUST ROD.....	21
•	THRUST ROD CONNECTION:.....	21
•	TRUNNION MOUNT .....	22
•	<b>4.5 WATER COOLING OPTION.....</b>	<b>22</b>
•	<b>5.0 CSW &amp; CSWX SERVOWELD™ ELECTRICAL INSTALLATION .....</b>	<b>23</b>
•	<b>5.1 EMC WIRING GUIDELINES .....</b>	<b>23</b>
•	CABLE ROUTING .....	23
•	SHIELDING AND GROUNDING .....	23
•	<b>5.2 CONNECTOR ORIENTATION .....</b>	<b>23</b>
•	<b>5.3 FEEDBACK INFORMATION.....</b>	<b>24</b>
•	5.3.1 FEEDBACK COMMUTATION.....	24
•	5.3.2 FEEDBACK COMMUTATION DETAILS.....	25
•	ABSOLUTE ENCODER FEEDBACK .....	25
•	RESOLVER FEEDBACK.....	25
•	SERVOMOTOR INFORMATION:.....	26
•	<b>5.4 CABLE AND CONNECTOR LEADS INFORMATION .....</b>	<b>27</b>
•	5.4.1 PINOUT TABLES .....	27
•	5.4.2 FEEDBACK WIRING.....	27
•	<b>5.5 CONNECTOR PINOUTS .....</b>	<b>28</b>
•	FEEDBACK CODE: A1 – ABB.....	28
•	FEEDBACK CODE: C1 - COMAU.....	29
•	FEEDBACK CODE: F1 - FANUC/AIAR128 .....	30
•	FEEDBACK CODE: F2 - FANUC/A64.....	31
•	FEEDBACK CODE: K1 - KUKA.....	32
•	FEEDBACK CODE: K4 - KUKA.....	33
•	FEEDBACK CODE: M1 - MOTOMAN YASKAWA.....	34
•	FEEDBACK CODE: N1 - NACHI; FD11 .....	35
•	FEEDBACK CODE: W1 - KAWASAKI; E-SERIES .....	36

- **6.0 CSW & CSWX OPERATION AND START UP CONSIDERATIONS .....37**
- **6.1 ATTACHING CABLES & HOMING / MECHANICAL TRAVEL LIMITS.....37**
- **6.2 BRAKE.....37**
  - **SERVOWELD™ BRAKE SPECIFICATIONS .....38**
- **7.0 CSW & CSWX MAINTENANCE & REPAIR.....39**
- **7.1 LUBRICATION.....39**
- **7.2 PERIODIC MAINTENANCE.....39**
  - **PROCEDURE FOR LUBRICATION.....40**
- **7.3 SERVOWELD™ REFURBISHMENT & REMANUFACTURING SERVICE.....40**
- **APPENDIX A: ACTUATOR SPECIFICATIONS .....41**
- **MOTOR SPECIFICATIONS: .....42**
  - **STANDARD THERMAL SWITCH SPECIFICATIONS .....42**
- **APPENDIX B: TROUBLESHOOTING PROCEDURE .....43**
- **APPENDIX C: WARRANTY .....45**
- **C.1 WARRANTY.....45**
  - **WARRANTY AND LIMITATION OF LIABILITY .....45**
  - **LIMITED WARRANTY .....45**
  - **LIMITATION OF LIABILITY .....46**
  - **PRODUCT RETURN PROCEDURE .....46**
- **APPENDIX D: DECLARATION OF CONFORMITY.....47**

**List of Tables and Figures:**

FIGURE 2.1: EXAMPLE OF SERVOwELD ACTUATOR INSTALLED ON “X” STYLE WELD GUN UNIT. .... 10

FIGURE 2.2: SERVOwELD CSWX ACTUATOR IDENTIFICATION LABEL FOR ACTUATORS MADE IN THE USA. .... 11

FIGURE 2.3: SERVOwELD CSW & CSWX ACTUATOR IDENTIFICATION LABEL FOR ACTUATORS MADE IN CHINA. .... 11

FIGURE 3.1: CSWX ORDERING CODES AND DESCRIPTIONS..... 14

FIGURE 4.1: TYPICAL CONNECTIONS FOR A SINGLE-AXIS SYSTEM WITH A SERVOwELD™ ACTUATOR WITH OPTIONAL BRAKE TO A RSW SERVO SYSTEM DRIVE..... 16

FIGURE 4.2: SIDE LOAD MUST NOT EXCEED MAXIMUM VALUES REPRESENTED BY THE LINES IN THE GRAPH ..... 18

FIGURE 4.3: FOR ROUND ROD, HOLD THRUST ROD STATIONARY USING A WRENCH ON THE FLATS AT THE END OF THE ROD WHEN ATTACHING ACCESSORIES, LINKAGES OR LOAD TO THE ACTUATOR. USE A TORQUE WRENCH TO TIGHTEN THE INTERFACING ROD END TO THE ACTUATOR THREADED CONNECTION POINT. TORQUE VALUES PROVIDED IN TABLE 2.2 ..... 20

FIGURE 4.4: FOR "DOUBLE D" ROD, HOLD THRUST ROD STATIONARY USING A WRENCH ON THE FLAT OF THE ROD WHEN ATTACHING ACCESSORIES, LINKAGES OR LOAD TO THE ACTUATOR. USE A TORQUE WRENCH TO TIGHTEN THE INTERFACING ROD END TO THE ACTUATOR THREADED CONNECTION POINT. TORQUE VALUES PROVIDED IN TABLE 2.2..... 21

TABLE 4.1: ROD END TORQUE RECOMMENDATIONS..... 21

TABLE 4.2: TAPPED HOLE TORQUE RECOMMENDATIONS ..... 21

FIGURE 4.5: VIEW OF CSWX WATER COOLING OPTION..... 22

FIGURE 5.1: RECOMMENDED ROUTING OF SERVOwELD CABLING..... 23

FIGURE 5.2: CONNECTOR ROTATION. NOTE THAT THE TOLOMATIC STANDARD CONNECTORS MAY BE ROTATED FROM -90° TO +180° ALLOWING FOR CABLES TO CONNECT TOWARD THE FRONT (ROD END, AS MANUFACTURED), TO EITHER SIDE, BOTH SIDES, OR BACK OF ACTUATOR. .... 24

FIGURE 5.3: DRAWING OF BOX MOUNT CONNECTORS USED ON SOME SERVOwELD ACTUATORS. .... 24

FIGURE 5.4: THRUST ROD MOVEMENT RELATIVE TO MOTOR ROTATION ..... 25

FIGURE 5.5: MOTOR ROTATIONAL POSITION AT 0 ..... 26

FIGURE 5.6: MOTOR ROTATIONAL POSITION AT 90..... 26

TABLE 5.1: ABSOLUTE ENCODER AND RESOLVER FEEDBACK DATA ..... 26

TABLE 5.2: SERVOwELD ACTUATOR POWER CABLE WIRE COLORS..... 27

TABLE 6.1: SERVOwELD BRAKE SPECIFICATIONS ..... 38

FIGURE 6.2: FASTEST ENGAGE / DISENGAGE TIME, LEAST PROTECTION ..... 38

TABLE 7.1: PERIODIC MAINTENANCE (RELUBRICATION) SCHEDULE ..... 39

FIGURE 7.1: A STANDARD GREASE ZERK ALLOWS PERIODIC RELUBRICATION FOR SERVOwELD ACTUATORS. THIS CAN TYPICALLY BE PERFORMED IN 5 MINUTES WITHOUT REMOVING THE ACTUATOR FROM ITS INSTALLATION. .... 39

## 1.0 Safety

### 1.1 Safety Symbols

#### General

Read completely through the applicable sections of the manual before the equipment/unit is unpacked, installed or operated. Pay careful attention to all of the dangers, warnings, cautions and notes stated in the manual.

Serious injury to persons or damage to the equipment may result if the information in the manual is not followed.

#### Safety Symbols

Items that are specifically marked DANGER, WARNING, CAUTION, PROHIBITIVE, MANDATORY ACTION, or NOTE! are arranged in a hierarchical system and have the following meaning:



Indicates a very hazardous situation which, if not avoided, could result in death or serious injury. This signal word is limited to the most extreme situations.



Indicates a potentially hazardous situation which, if not avoided, could result in death or serious injury.



Indicates a potentially hazardous situation which, if not avoided, may result in property damage, minor or moderate injury.



Indicates Prohibited Action



**MANDATORY ACTION**

Indicates Mandatory Action



**NOTE!**

Information that requires special attention is stated here.



**WARNING FOR HOT SURFACES**

WARNING! Normal operating temperature of weld actuator can range from 135 degrees F (57°C) to 175 degrees F (79°C).

## ■ 1.2 Safety Considerations

### ■ Proper and Safe Use of Product

#### ■ Fail Safe e-Stop Recommendations

When motor is attached, a means for a fail-safe e-stop is highly recommended to ensure equipment and personal safety. The e-stop should provide a means to remove main power from the actuator to cease and prevent any unwanted motion.

#### ■ Device Damage Prevention

To prevent permanent damage to the device, proper care should be taken not to exceed published voltage, current, temperature, and load/force ratings. In addition, proper mechanical assembly and proper wiring should be verified and safety measures checked before applying power to the complete equipment package.

#### ■ Personal Safety

During normal operation the motor can become hot, especially the motor housing. In addition, the case ground should be tied to an earth ground to prevent the presence of case voltage.

During normal operation, the actuator rod travels in and out creating a possible pinch point.

Proper guarding and signage must be used prevent entry into possible pinch zones and contact with hot surfaces. It is highly recommended to display proper safety notices and implement proper safety measures to prevent contact with hot surfaces.

#### ■ Handling and Unpacking

When unpacking and handling the actuator, care should be taken not to drop the actuator as this can damage the connectors, internal electronics, or cause misalignment of the actuator feedback device. Damage the internal mechanical components may cause poor performance or render the actuator non-functional. Since this is an electromechanical device, proper ESD measures should be taken to avoid static electricity from contacting the signal and power lines of the device, as this can damage the internal mechanical components rendering the actuator damaged or non-functional.

#### ■ Packing and Transport



##### NOTE!

Package actuator to prevent damage during transport. It is recommended that the actuator be returned in its original packaging. If the original packaging is not available, the follow these recommendations.

1. Foam in place if possible.
2. Reinforce ends of box with multiple layers of cardboard or wood to prevent the actuator from breaking through the packaging during shipment.
3. Support the connectors or cables so that enough packaging or foam is in place to prevent shipping damage.
4. It is best to ship one unit per container because individual items that are not isolated with stable packaging (foam in place) from each other often get damaged during shipment.
5. When shipping more than one unit in a single container, it is recommended to foam in place to prevent damage during shipping to both the units and the packaging.
6. Add the RMA number on the outside of the packaging. Failure to do so will delay processing.





**CAUTION!**

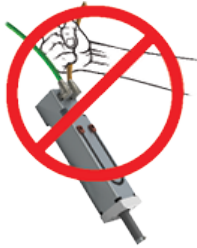

The CSW(X) ServoWeld™ actuator weight range is approximately 10.2 to 15.6 kg (22.6 to 34.5 lb). Special care must be taken when lifting this device. Do not carry by the connectors. The connectors are not rated to support the weight of the actuator.

### ■ Modifications to the Equipment



**WARNING!**

The manufacturer takes no responsibility whatsoever if the equipment is modified or if the equipment is used in any way beyond performance specifications. Unauthorized modifications or changes to the equipment are strictly forbidden and void all warranties.

### ■ Repair and Maintenance



**WARNING!**

All power and supply media must be shut OFF before any work is performed on any equipment that is associated with the actuator. The only field maintenance that may be performed on ServoWeld actuator include lubrication. All other repair or maintenance for ServoWeld actuator must be performed at Tolomatic or by a Tolomatic service center.

### ■ Requirement Regarding Personnel



**NOTE!**

All personnel must be completely informed regarding all safety regulations and the function of the equipment.

### ■ Risk Area and Personnel

When installed, pinch points are generated capable of damaging forces. The risk area surrounding the ServoWeld™ actuator must either be guarded or clearly marked, including display signage in accordance with all applicable national and international legal requirements. The risk area must be protected by a safety system that stops the equipment if anyone enters the risk area. Personnel who enter the risk area must be authorized, trained and qualified for the different tasks inside the risk area.



## 2.0 CSW & CSWX ServoWeld™ Product Overview:

### 2.1 General Description

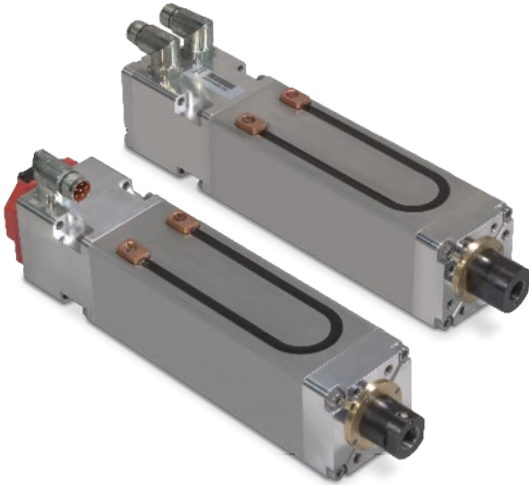

#### CSW and CSWX ServoWeld™ Actuators

The ServoWeld™ actuator (see figure 2.1) is a compact high-force, screw-drive servo actuator. The weld actuator provides linear motion of the moveable weld gun tip and develops the required thrust (squeeze) force for spot welding.

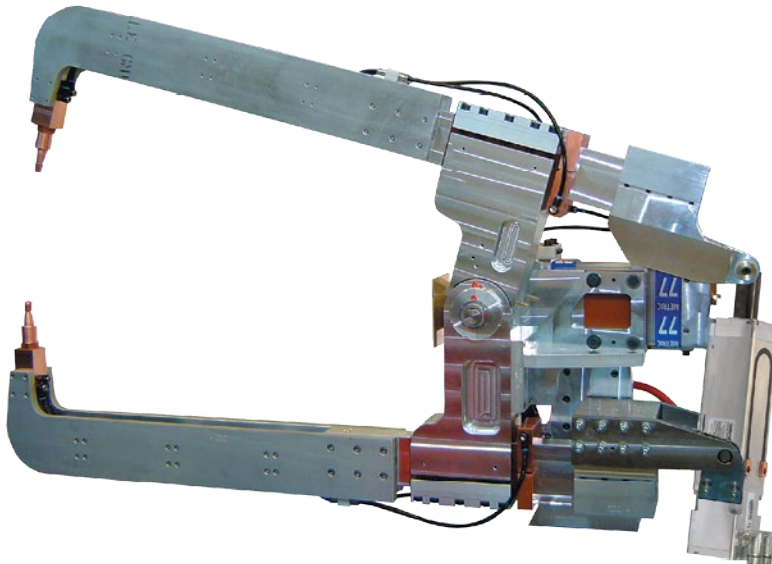

Figure 2.1: Example of ServoWeld actuator installed on “X” Style weld gun unit.

### 2.2 Intended Use

Commonly used in robotic and other applications the ServoWeld™ weld actuator is a compact high force roller screw drive servo actuator. The weld actuator provides linear motion of the moveable weld gun tip and develops the required thrust (squeeze) force for spot welding.

 **WARNING!**

Before installation and commissioning of the equipment, this manual and all accompanying manufacturer documents and manuals MUST be completely read by the appropriate personnel. All warning texts must be given special attention.

## 2.3 Storage

Pay attention to the following when storing the actuator:

- Perform repairs, maintenance and inspections before storing equipment to ensure that the equipment is in good working order.
- Make sure the equipment is placed in a suitable storage position (horizontal) to prevent damage to the connectors and electronics.
- Protect the feedback device, which is located at the blind (non-rod end) of the ServoWeld actuator.
- Store in clean and dry environment.
- After six (6) months of storage it is recommended to cycle two complete strokes of the ServoWeld actuator to redistribute the internal lubricants.

It is also recommended to cycle the ServoWeld actuator two complete strokes before placing in service.

- If stored for a period longer than 2 years without use it may be necessary to replace the lubricants. Return to Tolomatic for this maintenance.
- Storage temperature is -25°C to +60°C (-13°F to +140°F).

## 2.4 Identification Label

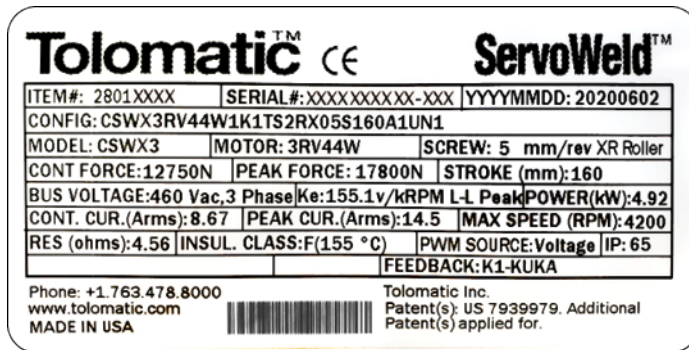

Figure 2.2: ServoWeld CSWX actuator identification label for actuators made in the USA.



Figure 2.3: ServoWeld CSW & CSWX actuator identification label for actuators made in China.

Do not remove the identification label. Do not render it unreadable.

## 2.5 Certification



## 2.6 Manufacturer

### USA - Headquarters

**Tolomatic Inc.**  
3800 County Road 116  
Hamel, MN 55340, USA  
**Phone:** (763) 478-8000  
Toll-Free: **1-800-328-2174**  
sales@tolomatic.com  
[www.tolomatic.com](http://www.tolomatic.com)

### MEXICO

**Centro de Servicio**  
Parque Tecnológico Innovación  
Int. 23, Lateral Estatal 431,  
Santiago de Querétaro,  
El Marqués, México, C.P. 76246  
**Phone:** +1 (763) 478-8000  
help@tolomatic.com

### EUROPE

**Tolomatic Europe GmbH**  
Elisabethenstr. 20  
65428 Rüsselsheim  
Germany  
**Phone:** +49 6142 17604-0  
help@tolomatic.eu

### CHINA

**Tolomatic Automation Products  
(Suzhou) Co. Ltd.**  
No. 60 Chuangye Street, Building 2  
Huqiu District, SND Suzhou  
Jiangsu 215011 - P.R. China  
**Phone:** +86 (512) 6750-8506  
ServoWeldChina@tolomatic.com

## ■ 3.0 CSW & CSWX ServoWeld™ Configuration Overview

### ■ 3.1 CSW, CSWX Series Configuration

- Two models: CSW & CSWX (high performance, long life)
- Internal Anti-Rotation Option (Double D rod style)
- Motor windings: 230 Vac & 460 Vac
- Feedback Choices:  
ABB Resolver, Comau Resolver, Emerson CT Hiperface, Fanuc a128  
Fanuc a64, Kuka Resolver, Motoman Absolute  
Nachi Absolute FD11 Series, Rockwell Automation Hiperface  
Rockwell Automation Hiperface DSL, Kawasaki Absolute E Series



#### **NOTE!**

For performance data and specifications please refer to the CSW catalog #2750-4027 or [CSWX catalog #2750-4024](#).

### ■ 3.2 Standard Configurations and Options



#### **NOTE!**

Please refer to the Tolomatic CSW catalog #2750-4027 or [CSWX catalog #2750-4024](#) for complete information on ordering codes. Use 3D CAD files (available at [www.tolomatic.com](http://www.tolomatic.com)) for critical dimensions.

# Ordering

MODEL SELECTION (MUST BE IN THIS ORDER)

**C S W X 3 S V 2 4 W 2 F 1 C S 1 R N 1 0 S 2 0 0 A 2 H F 1 - F A**

**MODEL**  
**CSWX** Compact ServoWeld X

**SIZE**  
**3** 3 Series; 90 mm square

**THERMAL PROTECTION**  
**F** Fanuc Proprietary  
**R** 600 ohm resistor in series with temperature switch  
**P** PT1000  
**S** Standard, temp. switch normally closed

**MOTOR VOLTAGE & STACKS**  
**23** 230 Vac, Motor Voltage, 3 Stack Winding  
**43** 460 Vac, Motor Voltage, 3 Stack Winding  
**24** 230 Vac, Motor Voltage, 4 Stack Winding  
**44** 460 Vac, Motor Voltage, 4 Stack Winding

**COOLING**  
**R1** Radiant Cooled  
**W1** Water Cooling, G 1/4 Thread, Connector Side  
**W2** Water Cooling, G 1/4 Thread, Opposite Connector

**FEEDBACK, CONNECTOR, WIRING**  
**A1** ABB Resolver  
**C1** Comau Resolver  
**F1** Fanuc a128  
**F2** Fanuc a64  
**K1** Kuka Resolver  
**M1** Motoman Absolute  
**N1** Nachi Absolute FD11 Series  
**W1** Kawasaki Absolute E Series  
**XX** Special

**FEEDBACK SUPPLIED BY:**  
**CS** Customer Supplied  
**TS** Tolomatic Supplied

**BRAKE OPTION**  
**1** NO Brake  
**2** 24V Brake  
**3** 90V Brake

**SCREW LEAD**  
**RN05XR** Roller Nut, 5 mm lead, Extended Roller Nut  
**RN10** Roller Nut, 10 mm lead

**STROKE LENGTH**  
**S160** 160mm (6.3") Stroke  
**S200** 200mm (7.9") Stroke  
**S250** 250mm (9.8") Stroke  
**S300** 300mm (11.8") Stroke

**ROD END OPTIONS**  
**A** Female M20  
**B** Female M16  
**C** 20 mm Spherical Rod Eye  
**D** 16 mm Spherical Rod Eye

**ROD-TYPE**  
**1** Round  
**2** Double D (Anti-rotate)

**ACTUATOR MOUNTING**  
**HF1** Standard Head 4 M8x1.25 tapped holes, 69mmx36mm pattern  
**UN1** Universal head 94mm square Mid Trunnion (contact Tolomatic)

**ADDITIONAL OPTIONS**  
 (Each separated by hyphen)  
**A** None  
**FA** Force Feedback Manual Override (Contact Tolomatic)

**⚠ Not all codes listed are compatible with all options.**

Call Tolomatic 1-800-328-2174 to determine available options and accessories based on your application requirements.

Figure 3.1: CSWX ordering codes and descriptions

### ■ 3.2.1 Internal Anti-Rotation Option

CSW, CSWX: In order to achieve linear motion with the CSW\_ a form of external anti rotation must be attached to the rod end. If the machine/application design does not allow for this, an internal anti-rotation option is available when ordering and is designated as with the code “2” in the appropriate position of the ordering code.

### ■ 3.2.2 Screw Selection

CSW: RN05, RN10: Roller nuts with 5mm or 10 mm lead.

CSWX: RX05, RN10: Roller nuts with 5mm extended or 10 mm lead.

RN05, RX05, RN10: Contact Tolomatic for application review and assistance in selecting a screw technology.

### ■ 3.2.3 Motor Voltage

CSW: 23, 43: Available with 230 Vac or 460 Vac with 3 stack windings.

CSWX: 23, 43, 24, 44: Available with 230 Vac or 460 Vac. With 3 stack or 4 stack windings.

Contact Tolomatic for application review and assistance in selecting voltage and windings.

### ■ 3.2.4 Water Cooling Option

Available for CSW & CSWX ServoWeld actuators the integrated water cooling option is 23% more efficient compared to external designs. It allows for increased duty cycle and more welds per hour.

### ■ 3.2.5 Mounting Options

Front face mount is standard. Please consult Tolomatic for any special mounting needs

### ■ 3.2.6 Rod End

Metric female threaded rod end is standard. Please consult Tolomatic for any special mounting needs.

### ■ 3.2.7 Internal Holding Brake Option

1=No Brake, 2=24V Brake, 3=90V Brake: A spring held electronically released holding brake (parking brake) is available. The holding force of the brake is capable of holding the continuous force of the actuator. The brake is spring set and releases when voltage is applied to the brake. A separate power source is required.

### ■ 3.2.8 Feedback Device

Contact Tolomatic for application review and assistance in selecting feedback device.

### ■ 3.2.9 Connector(s)

Connectors are matched to selected feedback device. Contact Tolomatic for application review and assistance in selecting feedback device.

### ■ 3.2.10 Servo Drive

The CSW & CSWX ServoWeld actuators functions in the same way as a brushless servo motor. A servo drive is used to power and control the actuator. Please consult the servo drive manufacturer when sizing and selecting a servo drive for use with CSW & CSWX ServoWeld.



#### **NOTE!**

The CSW & CSWX must be ordered with all desired options. Field installation of options generally cannot be done. Call Tolomatic for complete details.

## 4.0 CSW & CSWX ServoWeld™ Mechanical Installation

### **⚠ WARNING** WARNING!

Before installation and commissioning of the equipment, this manual and all accompanying manufacturer documents and manuals MUST be completely read by the appropriate personnel. All warning texts must be given special attention.

## 4.1 ServoWeld™ Actuator System Configuration

ServoWeld series actuators incorporate an integral brushless servo motor. The design of the motor with the proper feedback device and electrical connectors allows the actuator to be powered by the robot 7th axis of most robot manufacturers used in the automotive body shops and many commercially available servo drive/controllers. This flexibility allows the ServoWeld actuator to be used in the highest performing single and multi-axis motion control systems. It is recommended that all servo amplifiers and drives be selected based on the following important parameters:

- a) CE and UL approved system
- b) Thermal switch input
- c) Drive sizing key parameters for ServoWeld
  - i) Peak current
  - ii) Voltage
  - iii) Peak RPM
  - iv) Max current frequency

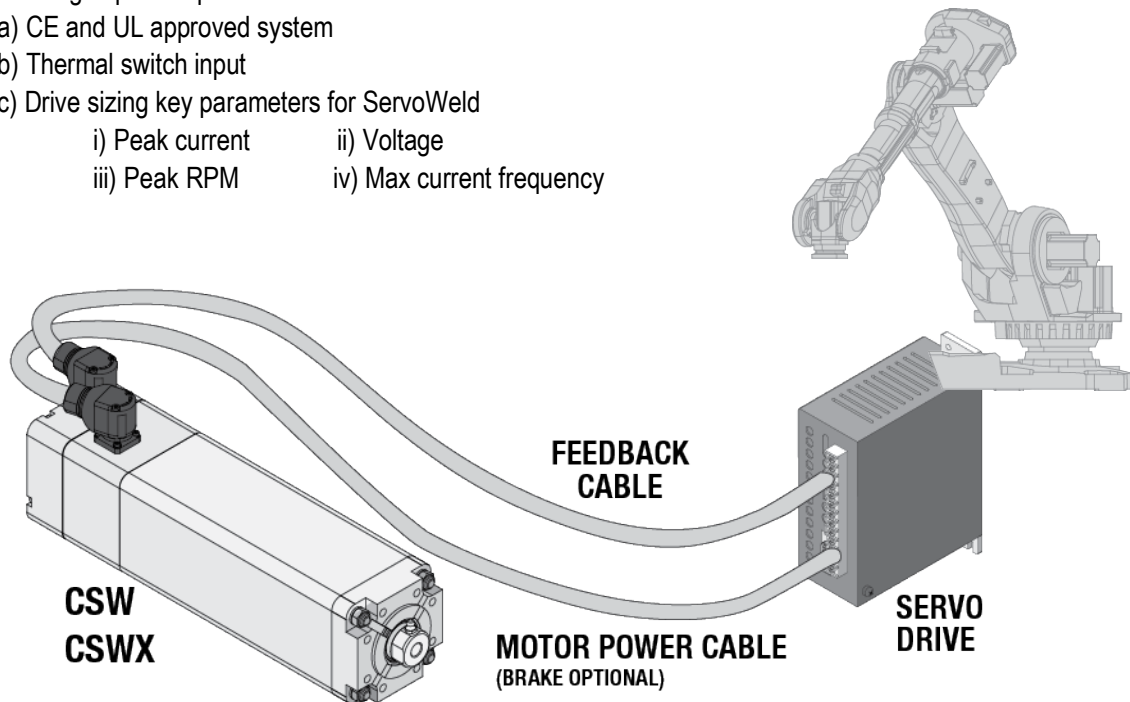

Figure 4.1: Typical connections for a single-axis system with a ServoWeld™ actuator with optional brake to a RSW servo system drive

## 4.2 Actuator Operation

### General Operation

The ServoWeld actuator functions by converting the rotary motion of the integral brushless servo motor into linear motion using a screw mechanism. The linear travel, speeds and forces are controlled in conjunction with a RSW servo system drive.

Each ServoWeld actuator is individually configured to work with the robot controller for the specific application. The relationship between the rotary motion of the motor and the linear motion of the actuator corresponds to the following relationships:

$$\text{Linear distance traveled} = (\text{motor revolutions}) * (\text{screw lead})$$

$$\text{Linear Speed} = ([\text{motor RPM}]/60) * (\text{screw lead})$$



**Linear Thrust (kN) = Motor torque (Nm) \* 2 \*  $\pi$  \* pitch (rev/mm) \* screw efficiency**

or

**Linear Thrust (lbf) = Motor torque (in•lb) \* 2 \*  $\pi$  \* pitch (rev/in) \* screw efficiency**

**⚠ CAUTION CAUTION!**

Motor RMS current must be maintained at a level below the continuous current rating of the ServoWeld actuator or damage to the motor stator will result.

The peak current setting must be maintained at a level below the peak current rating of the ServoWeld actuator or damage to the motor stator will result.

**⚠ CAUTION CAUTION!**

Care should be taken to not exceed the physical travel limits of the ServoWeld actuator. Doing so will cause the actuator to reach mechanical end of stroke internally. Although protected by the end of stroke bumpers, repeatedly reaching internal end of stroke can physically damage the screw and the internal components of the actuator.

**■ Cold Temperature Startup Procedure**

If startup ambient temperature is between 0-10 degrees Celsius, it is recommended to cycle the ServoWeld actuator (see recommended motion profile below) to bring the temperature up to operating temperature before proceeding with welding or calibrating the system. Initiating this startup procedure will lower the friction caused by cold temperatures and result in more accurate calibration of the system and better force repeatability performance during welding. If a motion profile other than recommended below will be used for the Cold Temperature Startup Procedure, contact Tolomatic for review of the motion profile before operating the actuator.

Recommended Motion Profile:

- Extend & retract full stroke of actuator at linear speed of 150 mm/sec for 5 mm lead screws and 300 mm/sec for 10 mm lead screws
- Dwell 1 second
- Repeat 75 times

**■ Tip Dress Procedure**

All forces are from thrust rod output of ServoWeld actuators ONLY and does not include the complete RSW weld gun system configurations. Each weld gun and robot servo controller/drive has different operational characteristics that influence low weld force tip capability (tip dress) of the complete servo RSW weld gun system. Other factors such as temperature and the percentage of maximum output force also affect the performance and force repeatability of tip dressing. If startup ambient temperature is in 0-10 degree Celsius range, please refer to Cold Temperature Startup Procedure.

- Minimum actuator output force: 1kN (225 lbf)
- Force repeatability at tip dress force [1.0 kN (225 lbf)]:  $\pm 5\%$  at steady state operating temperature

### 4.3 Planning Your Installation

To operate the actuator in compliance with the relevant safety regulations maximum performance limits must be observed.

**⚠ CAUTION CAUTION!**

When mounting your actuator in vertical or inclined positions be sure to include safety measures that control the working mass should the drive screw fail. Uncontrolled moving masses can cause injury or damage to property. If the screw drive fails, due to wear or excessive load, gravity may cause the working mass to drop.

**⚠ CAUTION CAUTION!**

For bench or fixture setup and testing of round rod ServoWeld actuators, the actuator thrust rod must be anti-rotated by a fixture and the actuator securely retained to the bench or fixture. Never use a hand held wrench/device to provide the anti-rotate function while the motor is powered as contact with the internal end of stroke may send the wrench/device flying and may harm the operator or damage the actuator.

#### ■ Installing the ServoWeld™ Weld Actuator

Please refer to the weld gun documentation supplied by the weld gun manufacturer for mechanical installation.

#### ■ Side Load Considerations

**⚠ CAUTION CAUTION!**

Excessive side load on the output thrust rod of the actuator will dramatically reduce the life of the actuator and should be avoided. Side load can be caused from misalignment or loading that is not inline with the actuator output thrust rod.



Some weld gun designs may subject the actuator to excessive side loading reducing overall service life. Measures are required, especially in "C" style designs, to limit side loading. For life optimization Tolomatic recommends side loads less than indicated in Figure 4.2

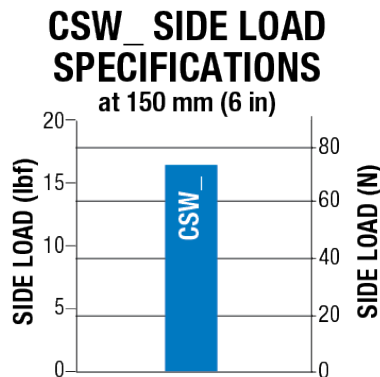

Figure 4.2: Side load must not exceed maximum values represented by the lines in the graph

The chart above shows the maximum side load values for the ServoWeld CSW actuators. Measures shall be established in gun design, especially in "C" style designs, to limit any side loading that exceeds these values. For maximum service life, external guiding is recommended to minimize side loading to the thrust rod and provide consistent weld gun movable tip/fixd tip alignment throughout service life.

### ■ Thrust Rod Wiper/Scraper

For maximum service life, measures should be taken to reduce/eliminate contamination, weld slag, and water in the thrust rod wiper/ scraper interface area. Implementation of industrial thrust rod boot and/or deflective device should be considered.

### ■ Cables

Shielded power and feedback cables are recommended to minimize electrical noise / grounding issues. Electrical noise or inadequate grounding can corrupt the feedback device signal.

#### CAUTION!

Power and Feedback cable lengths shall not exceed 10 meters (32.8 ft). If the application requires cable lengths longer than 10 meters please contact Tolomatic engineering for review.

### ■ RSW Servo System Calibration

For optimal RSW servo system performance, high weld force from the production weld schedule, tip dress force and multiple weld forces in between should be included in the RSW servo system Calibration process. RSW servo system consists of robot 7th axis amplifier-feedback device-software, ServoWeld™ actuator, and RSW chassis.

### ■ Weld Tip / Part Contact Speed

Tolomatic testing confirms the highest actuator repeatability (Input Current verses Output Force) at a weld tip part contact speed of 25mm/second or less. Speeds greater than 25mm/second can create “impact contribution” to the weld force. This impact contribution to the weld force deteriorates prior to completion of the weld cycle.

### ■ Robot Carried Applications

Robot carried RSW gun applications by virtue of the continuous robot movement and various RSW gun positions have reduced exposure to water pooling / water ingress. In addition, in robot carried applications, positioning of the RSW gun can be programmed as part of the weld cap change program /routine to eliminate actuator exposure to water. (ServoWeld™ actuator above weld caps)

### ■ Tool Changer Applications

Weld gun storage fixture in cell should position weld gun so movable electrode is not loading SeroWeld thrust rod - back driving the ServoWeld. Weld gun tips should be positioned to weld gun closed at low force prior to disconnect from robot/tool changer. Consider ServoWeld configured with integral brake option.

### ■ Fixed/Pedestal Applications

One of the more challenging RSW applications is a pedestal RSW gun, ServoWeld™ actuator mounted vertical – thrust rod up. Measures should be taken to reduce and/or eliminate the actuator to water exposure, water pooling/spray in the access areas of the ServoWeld unit to maximize overall service life. Because water is a factor in the RSW gun environment as a result of regular weld cap changes there are a number of steps can be taken to reduce and/or eliminate the actuator’s exposure to water.

- Pedestal RSW guns that can be mounted with the ServoWeld actuator vertical – thrust rod down should be considered.
- Pedestal RSW guns that must be mounted with the ServoWeld actuator vertical – thrust rod up should be mounted at an angle of a least 10 – 15% to minimize water pooling.
- Water channels are provided on the mounting face of the CSWX and CSW actuators. Care should be taken when mounting to ensure the channels are not obstructed to minimize water pooling.
- Any RSW gun applications that are suspect for water exposure should utilize an external deflector (bib) or a thrust rod boot to keep the water away from the thrust rod wiper/scraper interface area.
- Any RSW gun application that is suspect for water exposure should consider utilizing a manual shut-off valve in the water saver circuit at the RSW gun. Shutting off the water prior to weld cap change can significantly reduce water exposure issues in the RSW gun environment.

- Pedestal RSW gun applications should have the mating electrical connectors (90 degree) on the cable dress package facing down with the cable dress cables looped to reduce water ingress via the electrical connectors (power/feedback).
- Allow adequate cable length so the cables are not in tension.
- Molded mating electrical connectors on the cable dress package for pedestal RSW gun applications.
- Confirming full engagement of the cable dress connector to the appropriate mating receptacle on ServoWeld™ actuators.
- Earth ground the thrust rod when possible.

## ■ 4.4 Mounting

### ■ Thrust Rod Attachment - Round Thrust Rod

The design of the Round Rod ServoWeld actuator allows the extending rod to rotate. This provides simple setup of the actuator by allowing the user to rotate the rod and thread it in and out of the actuator for mechanical attachment or system testing. This feature also requires that the rod be kept from rotating when used in its dedicated application to insure proper linear motion. In most applications, such as those where the load is coupled to an external mechanical guide, or some other support device, the load cannot rotate, and thus provides anti-rotation for the extending rod of the actuator.

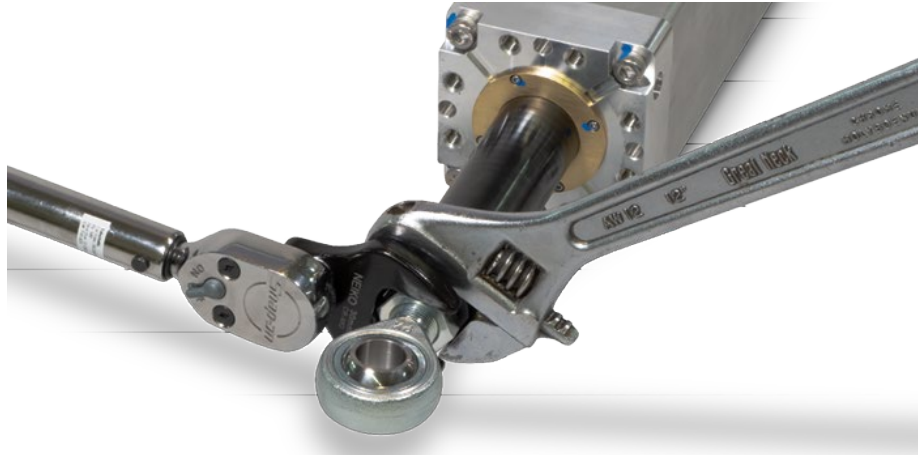

*Figure 4.3: For round rod, hold thrust rod stationary using a wrench on the flats at the end of the rod when attaching accessories, linkages or load to the actuator. Use a torque wrench to tighten the interfacing rod end to the actuator threaded connection point. Torque values provided in Table 2.2*

**Thrust Rod Attachment – Double Flat Thrust Rod**

The design of the Double Flat Thrust Rod ServoWeld actuator restricts the thrust rod from rotating. To setup the actuator the unit can be powered and moved into position, or the mating components may be moved to the connection point on the actuator. This feature provides the anti-rotation needed to generate proper linear motion.

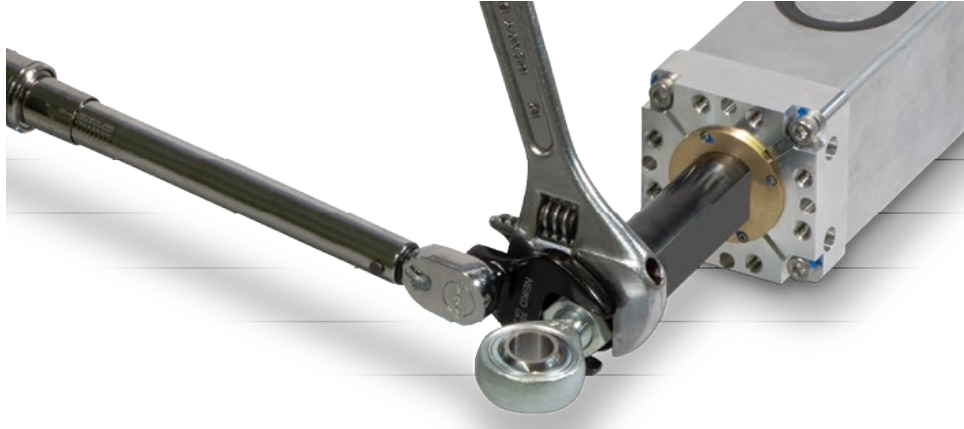

Figure 4.4: For "double d" rod, hold thrust rod stationary using a wrench on the flat of the rod when attaching accessories, linkages or load to the actuator. Use a torque wrench to tighten the interfacing rod end to the actuator threaded connection point. Torque values provided in Table 2.2

**⚠ WARNING WARNING!**

APPLYING TORQUE TO THE THRUST ROD MAY DAMAGE THE ACTUATOR. Avoid this by using a wrench to prevent the thrust rod from rotating while attaching the load, linkages or accessories to the rod end.

**Thrust Rod Connection:**

**ROD END ATTACHMENT FOR ROUND ROD ACTUATOR:** Hold flats on round rod stationary using a fixture, vise, or opposing wrench. Torque weld gun connection linkage or rod eye up to table value shown:

**ROD END ATTACHMENT FOR DOUBLE FLAT ROD ACTUATOR:** Hold flats on the thrust rod stationary using a fixture, vise, or opposing wrench. Do not rely on the anti-rotate feature inside the actuator to oppose the installation torque. Torque weld gun connection linkage or rod eye up to table value shown:

M12	80 N-m
	59 ft-lb

M16	200 N-m
	147.5 ft-lb

M20	200 N-m
	147.5 ft-lb

Table 4.1: Rod end torque recommendations

TAPPED HOLE MOUNTS RECOMMENDED TORQUE		
SIZE	MAXIMUM TORQUE	
M8	25 N-m	18 ft.-lbf
Front Face or Side Tapped Holes for M8x1.25 SHCS		
M10	45 N-m	33 ft-lbf
Side Tapped Holes for M10 x1.5 Shoulder Bolt or SHCS		

Table 4.2: Tapped hole torque recommendations

## ■ Trunnion Mount

Trunnion Mount – Trunnion mounts supplied per customer request, male or female, sized to fit the weld gun. Tolomatic supplies female Oilite Bushings when female trunnion mounting is requested. Mate trunnions with integral trunnion receptacles on the weld gun. Ensure the actuator pivots on the trunnion pins without binding.

## ■ 4.5 Water Cooling Option

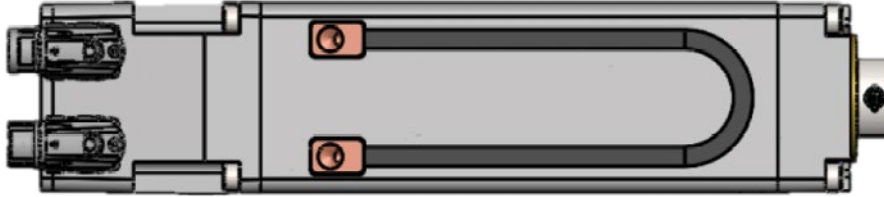

Figure 4.5: View of CSWX water Cooling Option

Water Flow Required:	1.9 to 3.8 LPM (0.5 to 1.0 GPM)
Water Inlet Temperature:	30° C (86° F) Max.
Coolant Line Thread:	G 1/4
Recommend Fitting Torque:	Hand thread in fitting as far as possible and then torque to 12 N-M or 105 in-lbf. Installer to verify fitting manufacturers torque spec meets this value.

## 5.0 CSW & CSWX ServoWeld™ Electrical Installation

### 5.1 EMC Wiring Guidelines

#### **⚠ WARNING** WARNING!

Thrust rod is not electrically connected to ground. The thrust rod should be earth grounded during installation for safety when possible.

#### **Cable routing**

It is recommended that the power and signal cables for ServoWeld™ actuators be routed as far apart as possible to minimize electrical noise in communication cables.

Over time, liquid contaminants such as oil and cleaning solutions may accumulate on the cables and into the connectors if they are an exposed type. To minimize the introduction of contaminants to the connector, route the cables so that there is a loop in the cable just prior to its attachment to the connector.

Examples are shown depending on the orientation of the connectors. Units mounted in such a way that the connectors are on the bottom surface of the actuator require no looping.

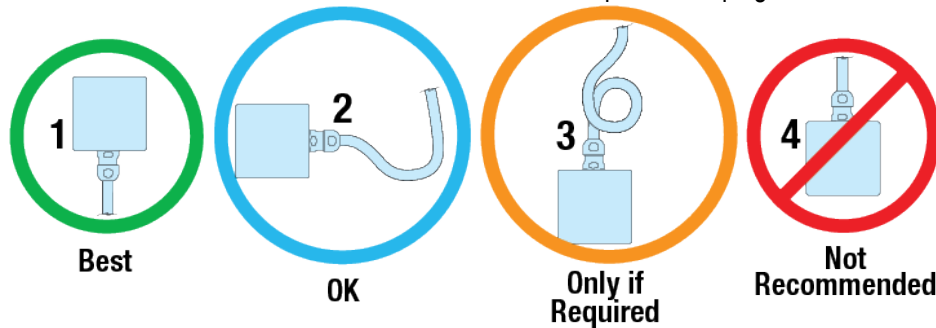

Figure 5.1: Recommended routing of ServoWeld cabling.

#### **Shielding and grounding**

Shielded cables are recommended. The standard cables provided by Tolomatic have an overall shield with drain wires and the case ground of the actuator is tied to a pin on the power connector. To minimize EMI and ensure system reliability, shield drain wires from all cables should be tied to a common earth ground.

#### **⚠ WARNING** WARNING!

Thrust rod is not considered an adequate ground.

### 5.2 Connector Orientation

The standard Tolomatic connectors are shown in figure 5.2 below. Tolomatic can mount the connectors in the orientation desired by the customer, or be rotated during installation. The ServoWeld™ actuator is manufactured to fit many different connector configurations. Many drive/robot manufacturers have specific connectors/pinout/wiring for integrating the ServoWeld actuator into operation. Reference Appendix B for available configurations. Depending on the connector choice, some connectors may be rotated from -90° to 180°.

For the Tolomatic standard connectors it is not necessary to loosen the screws retaining the connectors. Just carefully rotate to the desired orientation.

**NOTE!**

Do not apply excessive force while rotating connectors.

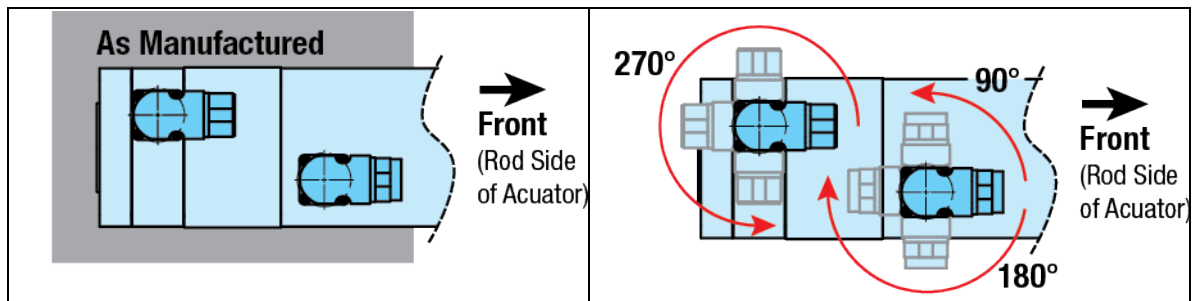

Figure 5.2: Connector rotation. Note that the Tolomatic standard connectors may be rotated from  $-90^\circ$  to  $+180^\circ$  allowing for cables to connect toward the front (rod end, as manufactured), to either side, both sides, or back of actuator.

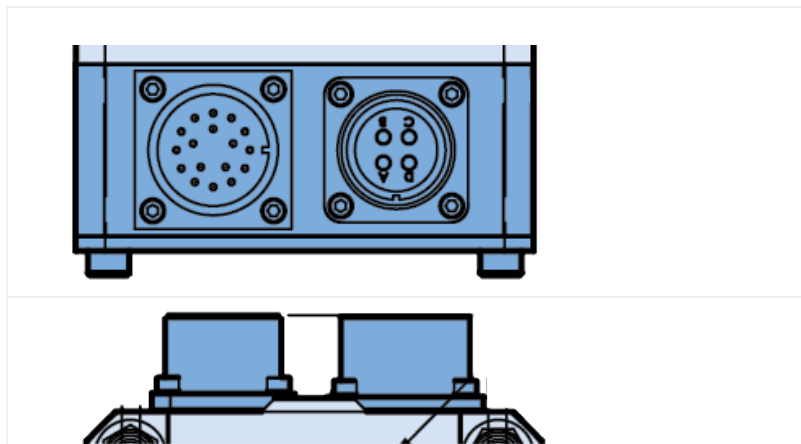

Figure 5.3: Drawing of box mount connectors used on some ServoWeld actuators. See individual encoder/connector in section 5.5 for details.

## 5.3 Feedback Information

The selection of the feedback device is typically dictated by the RSW servo system drive or robot controller used to operate the actuator. Each RSW servo system drive or robot controller has specific requirements for the feedback on the motor. ServoWeld actuators may use an incremental, single-turn absolute, multi-turn absolute, or resolver type rotary feedback device. Not all resolver-based RSW servo system drives or robot controller can use the same resolver, resolver alignment, or relative direction of resolver rotation. Many RSW servo system drives or robot controllers offer software that allows the entering of parameters or the downloading of "motor data files" that dictate how the feedback must be integrated with the motor. Tolomatic can provide the proper parameters to enter to create these "data files". Entering motor parameter data to some RSW servo system drives may require assistance from the RSW servo system drive/robot manufacturer.

### 5.3.1 Feedback Commutation

When Tolomatic manufactures a ServoWeld actuator, the proper feedback is selected, mounted, aligned and test run on an RSW servo system drive that is known to be equivalent to the RSW servo system drive that the customer plans to use for confirming proper feedback alignment and operation.



Feedback Type	Offset Alignment	Electrical Degree Tolerance
Fanuc	330 Degrees	+/- 5 Degrees
ABB	90 Degrees	+/- 5 Degrees
KUKA	90 Degrees	+/- 5 Degrees

### 5.3.2 Feedback Commutation Details

Terminology in the industry varies from motor supplier to motor supplier. One example is in the labeling of phases; some suppliers will reference phase R, S and T while others refer to U, V and W. With the differences in terminology visual explanations are used for clarification purposes.

Tolomatic ServoWeld Actuator motors are wired such that as the torque generating current vector progresses from phase U -> V -> W positive rotation is created. Positive rotation is defined as clockwise as viewed from the front face of the actuator. For reference, positive rotation will cause the thrust rod to extend.

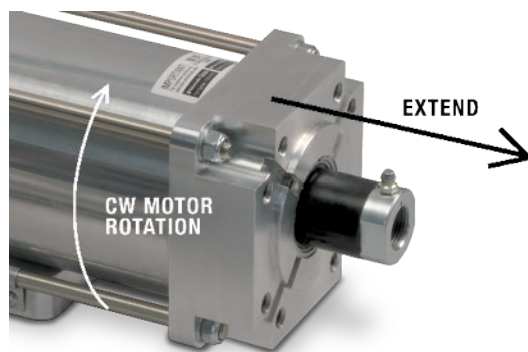

Figure 5.4: Thrust rod movement relative to motor rotation.

### Absolute Encoder Feedback

The standard commutation offset for Hiperface, Hiperface DSL, and EnDat absolute encoders in Servoweld actuators is set to 0 electrical degrees. This is accomplished by first locking the motor rotor with a current vector from phase U(+) to phase V and W (-), and then sending a set-zero position command to the encoder using the appropriate programming tool. The proprietary absolute encoders from Fanuc and Nikon, are aligned to specific angles that work with certain robot controllers. The Fanuc and Nikon absolute encoders in Servoweld actuators are set to 330 and 30 electrical degrees. This is accomplished by first locking the motor rotor with a current vector from phase U(+) to phase V(-) for Fanuc and from phase U(+) to phase W(-) for Nikon. The feedback device location is adjusted mechanically for both feedback devices.

(See Table 5.1)

### Resolver Feedback

The ServoWeld Actuator family is also offered with resolver feedback. A resolver must be excited with a sinusoidal input and outputs two signals, commonly referred to as cos and sin. These signal's magnitude and the phase angle relative to the excitation voltage are used by the drive to determine the absolute position (single rotational) of the motor's armature.

These actuators are aligned with a current vector from phase V (+) to phase W (-). At this location, the resolver body is rotated until the cos signal is null, and the sin signal is in phase with the excitation frequency.

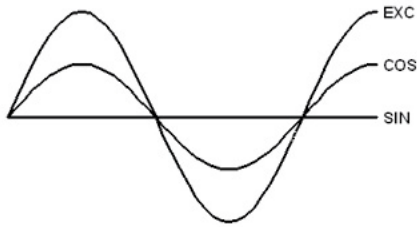

Figure 5.5: Motor rotational position at 0

Direction can be confirmed by rotating the shaft clockwise as viewed from the back, where, after 90 degrees of rotation the cos will now be in phase with the excitation frequency and the sin signal will be null.

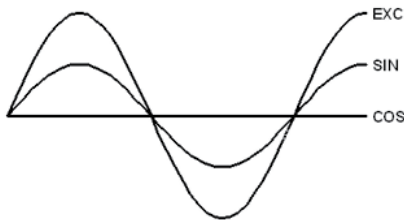

Figure 5.6: Motor rotational position at 90

Feedback Type	Offset Alignment	Electrical Degree Tolerance
Fanuc	330 Degrees	+/- 5 Degrees
Resolver TE	90 Degrees	+/- 5 Degrees
Resolver LTN	90 Degrees	+/- 5 Degrees
Hiperface	0 Degrees	+/- 5 Degrees
Hiperface DSL	0 Degrees	+/- 5 Degrees
EnDat 2.2	0 Degrees	+/- 5 Degrees
Nikon	30 Degrees	+/- 5 Degrees

Table 5.1: Absolute Encoder and Resolver Feedback data

#### ■ Servomotor Information:



#### NOTE!

See servomotor specifications in Tolomatic CSW catalog #2750-4027 or [CSWX catalog #2750-4024](#).



#### NOTE!

Do NOT exceed 650Vdc or 365 Vdc depending on motor selected, as it may cause damage to the actuator. Supplying the motor more than 110% of the rated motor voltage may increase the rotational speed of the motor greater than its specified maximum speed, leading to premature failure of the actuator



#### CAUTION!

In any case where it is determined that the feedback has become misaligned, or an RSW servo system drive change is made requiring the feedback to be aligned differently, it is recommended that Tolomatic be contacted and arrangements made to have that procedure performed.

## 5.4 Cable and Connector Leads Information

### 5.4.1 Pinout Tables

Wire Color	Wire AWG	Drive Phase
Black (U/L 1/C/L+)	16	U
Black (V/L2)	16	V
Black (W/L3/D/L-)	16	W
Green/Yellow	16	Earth/Ground
*White	20	BRK +
*Brown	20	BRK -

Table 5.2: ServoWeld Actuator Power Cable wire colors

Don't exceed rated motor voltage.

**Earth Grounds/Shielding:** The green wire or green wire with yellow stripe is the internal grounding terminal and shall be used as the equipment grounding means.

**\*Brake Information:** 24 Vdc power is required to release the brake during operation. A brown and white 20AWG lead exit the conduit opening as a pair and are used for brake wires. Ensure that these two wires are used for the brake.



#### NOTE!

The holding brake must be wired such that the servomotor will not turn unless 24V power is supplied to the brake. This ensures that the brake is released prior to spinning the motor.

### 5.4.2 Feedback Wiring

The wiring of the feedback device is critical to the operation of the actuator with the selected servo drive. The installer must not pull or tug on the encoder and brake wires when cutting, stripping and terminating as it may damage the small gauge wires which will prevent the actuator from operating.

Refer to Servo Drive User Manual for wiring instructions.



#### CAUTION!

In any case where it is determined that the feedback has become misaligned, or an RSW servo system drive change is made requiring the feedback to be aligned differently, it is recommended that Tolomatic be contacted and arrangements made to have that procedure performed.

## 5.5 Connector Pinouts

### NOTE!

The correct robot motor file must be selected for each actuator, robot, and robot controller. Please contact Tolomatic on any questions related the correct motor file selection.

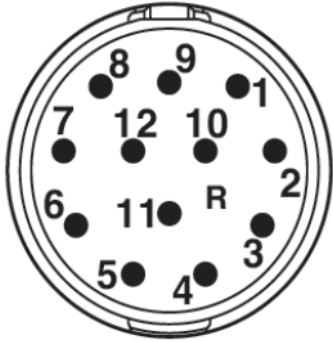
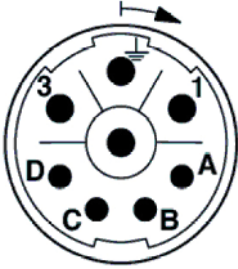

### Feedback Code: A1 – ABB

<b>Feedback Type:</b>	Resolver		
<b>Feedback Supply Voltage:</b>	Excitation 4 kHz		
<b>Positive Phase Sequence causes the thrust tube to:</b>	Extend		
<b>FEEDBACK CONNECTOR:</b>			
	<b>Style:</b>	Swivel	
	<b>Manufacturer:</b>	Phoenix Contacts	
	<b>Manufacturer P/N:</b>	RF-12P1N8AAD00	
	<b>Insert Clocking:</b>	Key over pin "9"	
	<b>Feedback Connector Pinout:</b>		
<b>Pin</b>	<b>Signal</b>	<b>Pin</b>	<b>Signal</b>
1	COS (S1)	7	NC
2	CPS LO (S3)	8	NC
3	SIN (S4)	9	NC
4	SIN LO (S2)	10	NC
5	EXC LO (R2)	11	NC
6	EXC (R1)	12	NC
<b>MOTOR POWER CONNECTOR:</b>			
	<b>Style:</b>	Swivel	
	<b>Manufacturer:</b>	Phoenix Contacts	
	<b>Manufacturer P/N:</b>	SF-7EP1N8AAD00	
	<b>Clocking:</b>	As Shown	
	<b>Motor Power Connector Pinout:</b>		
<b>Pin</b>	<b>Signal</b>	<b>Pin</b>	<b>Signal</b>
1	COS (S1)	A	Motor Thermal
2	CPS LO (S3)	B	Motor Thermal
3	SIN (S4)	C	NC
4	SIN LO (S2)	D	NC

### **WARNING!**

Feedback device, wiring and connector design are intended to operate with chosen robot controller or servo drive. Please verify robot controller/servo drive and mating cable are integrated for use with ServoWeld™ actuator before attempting to operate. Damage to the actuator or unintended operation could occur if not properly matched.

■ Feedback Code: C1 - COMAU

<b>Feedback Type:</b>	Resolver				
<b>Feedback Supply Voltage:</b>	Excitation 4 kHz				
<b>Positive Phase Sequence causes the thrust tube to:</b>	Extend				
<b>FEEDBACK CONNECTOR:</b>					
	<b>Style:</b>	Straight			
	<b>Manufacturer:</b>	Intercontec			
	<b>Manufacturer P/N:</b>	A EG A 052 MR 83 00 0201 000			
	<b>Insert Clocking:</b>	Key over pin "8"			
	<b>Feedback Connector Pinout:</b>				
<b>Pin</b>	<b>Signal</b>		<b>Pin</b>	<b>Signal</b>	
1	SIN LO (S2)		7	EXC LO (R2)	
2	SIN (S4)		8	Motor Thermal	
3	NC		9	Motor Thermal	
4	NC		10	EXC (R1)	
5	SHIELD		11	CPS (S1)	
6	NC		12	COS LO (S3)	
<b>MOTOR POWER CONNECTOR:</b>					
	<b>Style:</b>	Straight			
	<b>Manufacturer:</b>	Intercontec			
	<b>Manufacturer P/N:</b>	B EG A 116 MR 14 00 0200 000			
	<b>Clocking:</b>	As Shown			
	<b>Pin</b>	<b>Signal</b>		<b>Pin</b>	<b>Signal</b>
1	Phase T (W)		4	NC	
2	Phase S (V)		5	NC	
3	CHASSIS GND		6	Phase R (U)	



**WARNING!**

Feedback device, wiring and connector design are intended to operate with chosen robot controller or servo drive. Please verify robot controller/servo drive and mating cable are integrated for use with ServoWeld™ actuator before attempting to operate. Damage to the actuator or unintended operation could occur if not properly matched.

Feedback Code: F1 - Fanuc/aiAR128

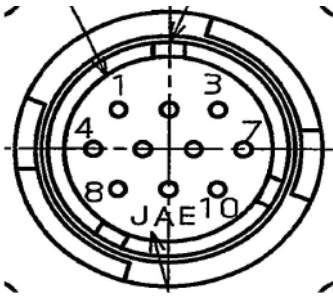
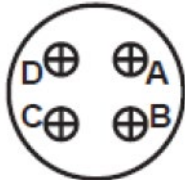
<b>Feedback Type:</b>	Absolute				
<b>Feedback Supply Voltage:</b>	+5V ±5%				
<b>Positive Phase Sequence causes the thrust tube to:</b>	Retract				
<b>FEEDBACK CONNECTOR:</b>					
	<b>Style:</b>	Box			
	<b>Manufacturer:</b>	Proprietary			
	<b>Manufacturer P/N:</b>	Proprietary			
	<b>Insert Clocking:</b>	As shown			
	<b>Feedback Connector Pinout:</b>				
<b>Pin</b>	<b>Signal</b>		<b>Pin</b>	<b>Signal</b>	
1	NC		6	RD	
2	NC		7	0 V	
3	NC		8	+5 V	
4	+6 V A		9	+5 V	
5	RD -		10	0 V	
<b>MOTOR POWER CONNECTOR:</b>					
	<b>Style:</b>	Box			
	<b>Manufacturer:</b>	Amphenol			
	<b>Manufacturer P/N:</b>	MS3102A18-10P			
	<b>Clocking:</b>	Key between pins "A" & "D"			
	<b>Pin</b>	<b>Signal</b>			
A	Phase R (U)				
B	Phase S (V)				
C	Phase T (W)				
D	GND				

**⚠ WARNING** WARNING!

Feedback device, wiring and connector design are intended to operate with chosen robot controller or servo drive. Please verify robot controller/servo drive and mating cable are integrated for use with ServoWeld™ actuator before attempting to operate. Damage to the actuator or unintended operation could occur if not properly matched.



Feedback Code: F2 - Fanuc/A64

<b>Feedback Type:</b>	Absolute			
<b>Feedback Supply Voltage:</b>	DC +5V ±5%			
<b>Positive Phase Sequence causes the thrust tube to:</b>	Retract			
<b>FEEDBACK CONNECTOR:</b>				
	<b>Style:</b>	Box		
	<b>Manufacturer:</b>	Proprietary		
	<b>Manufacturer P/N:</b>	Proprietary		
	<b>Insert Clocking:</b>	Key between pins "K" & "L"		
	<b>Feedback Connector Pinout:</b>			
	<b>Pin</b>	<b>Signal</b>	<b>Pin</b>	<b>Signal</b>
	A	SD	K	+ 5 V
	B	NC	L	SHIELD
	C	NC	M	NC
	D	SD -	N	0 V
E	NC	P	NC	
F	REQ	R	+6 V A	
G	REQ -	S	0 V A	
H	NC	T	0 V	
J	+5 V			
<b>MOTOR POWER CONNECTOR:</b>				
	<b>Style:</b>	Box		
	<b>Manufacturer:</b>	Amphenol		
	<b>Manufacturer P/N:</b>	MS3102A18-10P		
	<b>ClOCKING:</b>	Key between pins "A" & "D"		
	<b>Pin</b>	<b>Signal</b>		
A	Phase R (U)			
B	Phase S (V)			
C	Phase T (W)			
D	GND			

**⚠ WARNING** WARNING!

Feedback device, wiring and connector design are intended to operate with chosen robot controller or servo drive. Please verify robot controller/servo drive and mating cable are integrated for use with ServoWeld™ actuator before attempting to operate. Damage to the actuator or unintended operation could occur if not properly matched.

Feedback Code: K1 - KUKA

<b>Feedback Type:</b>	Resolver				
<b>Feedback Supply Voltage:</b>	Excitation 4 kHz				
<b>Positive Phase Sequence causes the thrust tube to:</b>	Retract				
<b>FEEDBACK CONNECTOR:</b>					
	<b>Style:</b>	Swivel			
	<b>Manufacturer:</b>	Intercontec			
	<b>Manufacturer P/N:</b>	AEDC 052 MR04 00 0200 000			
	<b>Insert Clocking:</b>	Key over pin "8"			
	<b>Feedback Connector Pinout:</b>				
<b>Pin</b>	<b>Signal</b>		<b>Pin</b>	<b>Signal</b>	
1	SIN (S2)		7	EXC LO (R2)	
2	SIN LO (S4)		8	Motor Thermal	
3	NC		9	Motor Thermal	
4	NC		10	EXC (R1)	
5	NC		11	COS (S1)	
6	GND		12	COS LO (S3)	
<b>MOTOR POWER CONNECTOR:</b>					
	<b>Style:</b>	Swivel			
	<b>Manufacturer:</b>	Intercontec			
	<b>Manufacturer P/N:</b>	BEDC 106 MR14 00 0200 000			
	<b>Clcking:</b>	As Shown			
	<b>Pin</b>	<b>Signal</b>		<b>Pin</b>	<b>Signal</b>
1	Phase R (U)		4	BRK + (IF AVAIL.)	
2	Phase S (V)		5	BRK - (IF AVAIL.)	
3	GND		6	Phase T (W)	





**WARNING!**

Feedback device, wiring and connector design are intended to operate with chosen robot controller or servo drive. Please verify robot controller/servo drive and mating cable are integrated for use with ServoWeld™ actuator before attempting to operate. Damage to the actuator or unintended operation could occur if not properly matched.



Feedback Code: K4 - KUKA

<b>Feedback Type:</b>	Resolver				
<b>Feedback Supply Voltage:</b>	Excitation 4 kHz				
<b>Positive Phase Sequence causes the thrust tube to:</b>	Retract				
<b>FEEDBACK CONNECTOR:</b>					
	<b>Style:</b>	Swivel			
	<b>Manufacturer:</b>	Intercontec			
	<b>Manufacturer P/N:</b>	AEDC 052 MR04 00 0200 000			
	<b>Insert Clocking:</b>	Key over pin "8"			
	<b>Feedback Connector Pinout:</b>				
<b>Pin</b>	<b>Signal</b>		<b>Pin</b>	<b>Signal</b>	
1	SIN (S2)		7	EXC LO (R2)	
2	SIN LO (S4)		8	PT1000	
3	NC		9	PT1000	
4	NC		10	EXC (R1)	
5	NC		11	COS (S1)	
6	GND		12	COS LO (S3)	
<b>MOTOR POWER CONNECTOR:</b>					
	<b>Style:</b>	Swivel			
	<b>Manufacturer:</b>	Intercontec			
	<b>Manufacturer P/N:</b>	BEDC 106 MR14 00 0200 000			
	<b>Clocking:</b>	As Shown			
	<b>Motor Power Connector Pinout:</b>				
<b>Pin</b>	<b>Signal</b>		<b>Pin</b>	<b>Signal</b>	
1	Phase R (U)		4	BRK + (IF AVAIL.)	
2	Phase S (V)		5	BRK - (IF AVAIL.)	
3	GND		6	Phase T (W)	

**⚠ WARNING** WARNING!

Feedback device, wiring and connector design are intended to operate with chosen robot controller or servo drive. Please verify robot controller/servo drive and mating cable are integrated for use with ServoWeld™ actuator before attempting to operate. Damage to the actuator or unintended operation could occur if not properly matched.

Feedback Code: M1 - MOTOMAN YASKAWA

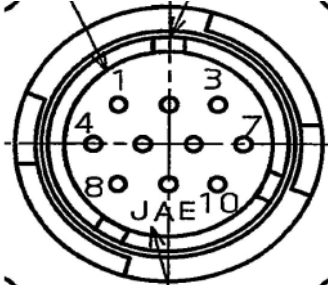
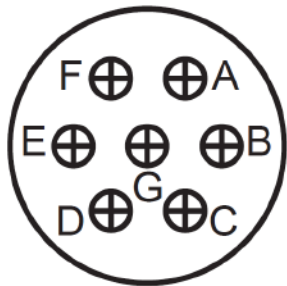
<b>Feedback Type:</b>	Absolute		
<b>Feedback Supply Voltage:</b>	DC +5V ±5%		
<b>Positive Phase Sequence causes the thrust tube to:</b>	Retract		
<b>FEEDBACK CONNECTOR:</b>			
	<b>Style:</b>	BOX	
	<b>Manufacturer:</b>	JAE	
	<b>Manufacturer P/N:</b>	JN2AS10ML1	
	<b>Insert Clocking:</b>	As shown	
	<b>Feedback Connector Pinout:</b>		
<b>Pin</b>	<b>Signal</b>	<b>Pin</b>	<b>Signal</b>
1	DATA +	6	BATTERY +
2	DATA	7	FRAME GROUND
3	NC	8	NC
4	+5 VDC	9	0 V
5	BATTERY -	10	NC
<b>MOTOR POWER CONNECTOR:</b>			
	<b>Style:</b>	Box	
	<b>Manufacturer:</b>	Amphenol	
	<b>Manufacturer P/N:</b>	MS3102A20-15P	
	<b>Clocking:</b>	Key between pins "A" & "F"	
	<b>Motor Power Connector Pinout:</b>		
<b>Pin</b>	<b>Signal</b>	<b>Pin</b>	<b>Signal</b>
A	Phase T (W)	E	Motor Thermal
B	Phase S (V)	F	Motor Thermal
C	Phase R (U)	G	NC
D	GND		

**⚠ WARNING** WARNING!

Feedback device, wiring and connector design are intended to operate with chosen robot controller or servo drive. Please verify robot controller/servo drive and mating cable are integrated for use with ServoWeld™ actuator before attempting to operate. Damage to the actuator or unintended operation could occur if not properly matched.

Feedback Code: N1 - NACHI; FD11

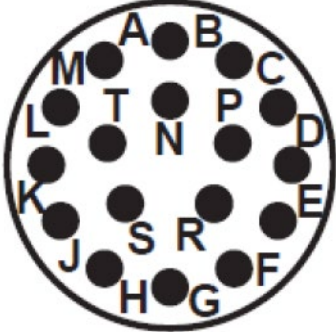
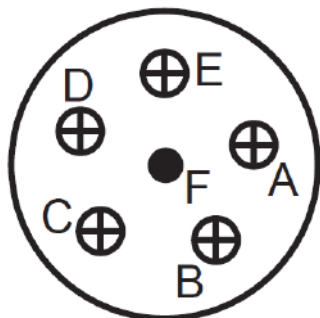
<b>Feedback Type:</b>	Absolute		
<b>Feedback Supply Voltage:</b>	DC +5V ±5%		
<b>Positive Phase Sequence causes the thrust tube to:</b>	Retract		
<b>FEEDBACK CONNECTOR:</b>			
	<b>Style:</b>	BOX	
	<b>Manufacturer:</b>	Amphenol	
	<b>Manufacturer P/N:</b>	MS3102A20-29P	
	<b>Insert Clocking:</b>	Key over pin "A"	
	<b>Feedback Connector Pinout:</b>		
<b>Pin</b>	<b>Signal</b>	<b>Pin</b>	<b>Signal</b>
A	NC	K	NC
B	NC	L	NC
C	NC	M	Motor Thermal
D	NC	N	Motor Thermal
E	SD+	P	NC
F	SD-	R	NC
G	GND	S	BAT -
H	Vcc	T	BAT +
J	GND		
<b>MOTOR POWER CONNECTOR:</b>			
	<b>Style:</b>	Box	
	<b>Manufacturer:</b>	Amphenol	
	<b>Manufacturer P/N:</b>	MS3102A20-17P	
	<b>Clocking:</b>	Key over pin "E"	
	<b>Motor Power Connector Pinout:</b>		
<b>Pin</b>	<b>Signal</b>	<b>Pin</b>	<b>Signal</b>
A	Phase T (W)	D	NC
B	Phase S (V)	E	NC
C	Phase R (U)	F	GND

**⚠ WARNING** WARNING!

Feedback device, wiring and connector design are intended to operate with chosen robot controller or servo drive. Please verify robot controller/servo drive and mating cable are integrated for use with ServoWeld™ actuator before attempting to operate. Damage to the actuator or unintended operation could occur if not properly matched.

Feedback Code: W1 - KAWASAKI; E-Series

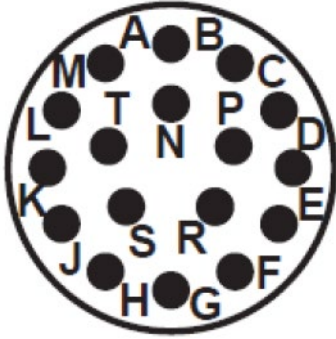
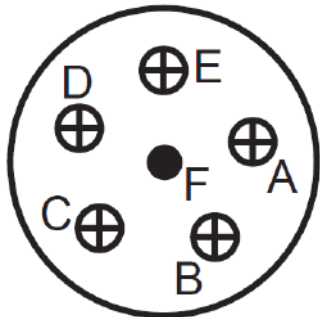
<b>Feedback Type:</b> Absolute			
<b>Feedback Supply Voltage:</b> DC +5V ±5%			
<b>Positive Phase Sequence causes the thrust tube to:</b> Retract			
<b>FEEDBACK CONNECTOR:</b>			
	<b>Style:</b> Box		
	<b>Manufacturer:</b> Amphenol		
	<b>Manufacturer P/N:</b> MS3102A20-29P-W		
	<b>Insert Clocking:</b> Key between pins "K" & "L"		
<b>Feedback Connector Pinout:</b>			
<b>Pin</b>	<b>Signal</b>	<b>Pin</b>	<b>Signal</b>
A	SD	G	NC
B	SD -	H	NC
C	Vcc	J	NC
D	GND	K	NC
E	CHASSIS GND	L	NC
F	NC	M	NC
		N	NC
		P	NC
		R	NC
		S	NC
		T	NC
<b>MOTOR POWER CONNECTOR:</b>			
	<b>Style:</b> Box		
	<b>Manufacturer:</b> Amphenol		
	<b>Manufacturer P/N:</b> MS3102A20-17P		
	<b>Clocking:</b> Key over pin "E"		
<b>Pin</b>	<b>Signal</b>	<b>Pin</b>	<b>Signal</b>
A	Phase R (U)	D	NC
B	Phase S (V)	E	NC
C	Phase T (W)	F	CHASSIS GND
<b>Style:</b> Box			
<b>Manufacturer:</b> Turck			
<b>Manufacturer P/N:</b> FS4.4			
<b>Pin</b>	<b>Signal</b>		
1	Motor Thermal		
2	NC		
3	NC		
4	Motor Thermal		

**⚠ WARNING** WARNING!

Feedback device, wiring and connector design are intended to operate with chosen robot controller or servo drive. Please verify robot controller/servo drive and mating cable are integrated for use with ServoWeld™ actuator before attempting to operate. Damage to the actuator or unintended operation could occur if not properly matched.

## 6.0 CSW & CSWX Operation and Start Up Considerations

### 6.1 Attaching Cables & Homing / Mechanical Travel Limits

1. Carefully align each cable connector with the respective motor connector.
2. Fully seat the cable to the feedback and power connectors.
3. Verify continuity and functionality of the thermal switch signals, TS+ and TS-. These signals are transmitted through the cables that connects the motor to its motion control system.
4. When homing the ServoWeld™ actuator avoid excessive force. During homing do not exceed 20% of continuous thrust or speeds of 0.1 in/sec (2.5 mm/sec).exceeding these recommendations can cause permanent damage to the actuator. Careful attention should always be taken to prevent exceeding the physical limits of the actuator.

#### CAUTION! CAUTION!

The mechanical travel limits of the actuator must be verified to ensure the actuator will not reach an internal hard limit during normal operation. The end of stroke bumpers should NOT be engaged during normal programmed servo actuator operation.

### 6.2 Brake

#### WARNING! WARNING!

In all vertical application an un-powered ServoWeld CSW or CSWX actuator will require a brake to maintain position. Tolomatic recommends that the nominal back drive force specification (listed on page 26) be used for reference only. Back drive force is subject to change throughout the life of the actuator, due to mechanical break in, ambient temperature, and duty cycle variation.

A brake can be used with the actuator to keep it from backdriving, typically in vertical applications. A brake may be used for safety reasons or for energy savings allowing the actuator to hold position when un-powered.

#### NOTE!

The optional Spring-Applied / Electronically-Released Brake typically requires 24V or 90V power (depending on robot manufacturer).

The brake is spring engaged and electrically released.

#### CAUTION! CAUTION!

DO NOT attempt to operate the actuator with the brake applied. Allowing the actuator to operate with the brake applied may cause serious damage to the actuator and/or the brake. Do not use the brake to support heavy loads while an operator is under the load. Provide another means to lock the load in position. The brake is a spring applied friction mechanism and does not provide a positive lock.

## ServoWeld™ Brake Specifications

	SERIES	CSW_
ROTOR INERTIA	gm-cm <sup>2</sup>	260
	oz-in <sup>2</sup>	1.422
CURRENT	Amp	0.67
HOLDING TORQUE	N-m	5.0
	In-lb	44
ENGAGE TIME	mSec	35

	SERIES	CSW_
ENGAGE TIME WITH DIODE	mSec	80
DISENGAGE TIME	mSec	25
VOLTAGE	Vdc	24

Table 6.1: ServoWeld brake specifications

Protecting the brake from voltage transients in applications where it will be engaged and disengaged frequently is advised. The use of a rectifying diode and zener diode will provide optimal protection against these transients.

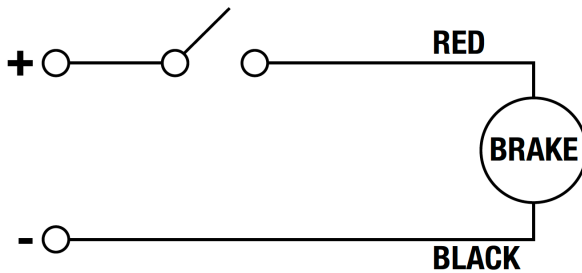

Figure 6.2: Fastest Engage / Disengage time, least protection

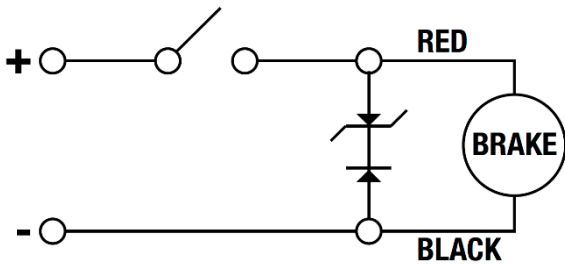

Figure 6.3: Increased Engage / Disengage time, best protection

## 7.0 CSW & CSWX Maintenance & Repair

### 7.1 Lubrication

NEW UNIT: All ServoWeld™ actuators have been lubricated at the factory and are ready for installation. If the actuator is placed in storage for more than 1 year after it is received, the actuator should be lubricated through the lubrication port on the thrust rod with 20 grams (0.7 oz) or 23 ml (0.75 fl oz) of Kluber Isoflex Topas NCA52 grease (Tolomatic, PN: 1150-1017) and cycled at least two full strokes prior to running in a loaded condition.

Lubrication needs in a given application are dependent on multiple factors:

- Ambient temperature of environment
- Weld Schedule:
  - Number of open/close (long moves) per minute
  - Number of welds per minute
  - Actuator thrust rod force required

### 7.2 Periodic Maintenance

PERIODIC MAINTENANCE: The forces in different applications impact the life of the grease in the actuator. Tolomatic recommends a simple, 5 minute maintenance procedure based on Table 7.1 for typical weld gun styles. For questions about your specific application, contact Tolomatic Customer Support.

Weld Gun Type	PM Schedule (weld cycles)
C gun	10,000,000
X gun / Pinch gun	5,000,000

Table 7.1: Periodic Maintenance (relubrication) Schedule

For optimal performance and maximum life, consider performing this simple maintenance every 5,000,000 weld cycles.

#### NOTE!

Tolomatic also recommends validating the output force after 100,000 cycles and on an annual basis thereafter. It is recommended that the actuator be visually inspected after initial startup and twice a year thereafter, specifically checking for uneven wear or discoloration of the thrust rod which may indicate side loading and lead to premature seal failure. Contact the nearest Tolomatic service center with any concerns or questions.

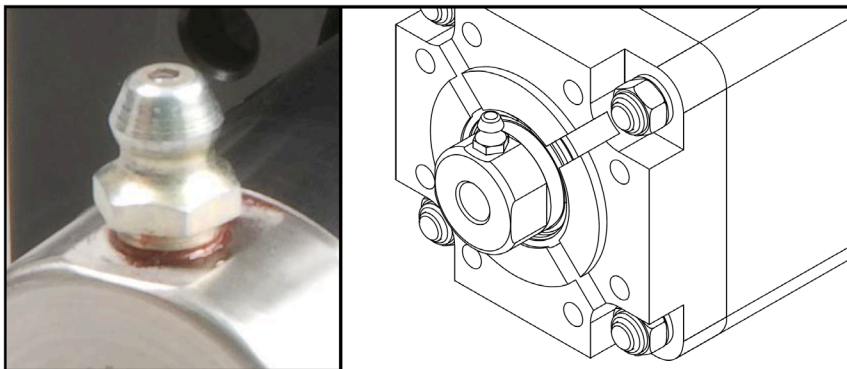

Figure 7.1: A standard grease zerk allows periodic relubrication for ServoWeld actuators. This can typically be performed in 5 minutes without removing the actuator from its installation.

## ■ Procedure for lubrication

### NOTE!

Before starting any maintenance activities, confirm ServoWeld actuator is in full retract position and supply power is shut off.

1. Ensure ServoWeld actuator is in full retract position
2. Using a standard grease gun, apply the following amounts of grease into the grease Zerk on the rod end of the actuator:
  - a. CSW\_3: 20 grams (0.7 oz) or 23 ml (0.75 fl oz)

### NOTE!

Use Kluber Isoflex Topas NCA52 grease. Available from Tolomatic, PN: 1150-1017

3. Re-apply power to the ServoWeld actuator
4. Using the Robot teach pendant, complete five full extend / full retract moves of the ServoWeld actuator at low speed / low force to properly distribute the grease

### CAUTION! CAUTION!

Do not over-fill with grease

Overfilling will cause a reduction in performance, excessive heat buildup and potential premature failure.

## ■ 7.3 ServoWeld™ Refurbishment & Remanufacturing Service

Tolomatic factory refurbishment or remanufacturing service is available for any ServoWeld™ actuator. This service will return the ServoWeld actuator to factory specs.

### **Refurbishment Service includes:**

- Replace thrust rod
- Replace wiper/scrapper components
- Visually inspect for additional worn or broken components
- Clean roller screw and nut
- Re-lubricate the roller screw and nut
- Re-assemble the actuator
- Functional test to assure unit is fully operational to original specifications

### **Remanufacturing Service includes:**

- Replace thrust rod
- Replace wiper/scrapper components
- Visually inspect for additional worn or broken components
- Replace roller screw/nut assembly
- Replace main bearing
- Re-assemble the actuator
- Functional test to assure unit is fully operational to original specifications
- 1 year warranty from date of shipment



## Appendix A: Actuator Specifications

Table 1: Performance & Mechanical Specifications:



SERIES		CSW		CSWX			
FRAME SIZE	mm	90.0		90.0			
	in	3.54		3.54			
MOTOR WINDING		V23 / V43		V23 / V43		V24 / V44	
NUT/SCREW		RN05	RN10	RN05XR	RN10	RN05XR	RN10
SCREW LEAD	mm	5.0	10.0	5.0	10.0	5.0	10.0
PEAK FORCE	kN	15.6	7.9	15.8	7.9	18.0	10.5
	lbf	3500	1780	3560	1780	4047	2350
MAX. VELOCITY	mm/sec	342 / 350	683 / 700	342 / 350	683 / 700	350	700
	in/sec	13.5 / 13.8	26.9/27.6	13.5 / 13.8	26.9/27.6	13.8	27.6
SCREW DLR (DYNAMIC LOAD RATING)	kN	73.3	76.4	91.7	76.4	91.7	76.4
	lbf	16,479	17,175	20,623	17,175	20,623	17,175
NOMINAL BACK DRIVE FORCE	N	405	205	405	205	405	205
	lbf	91	46	91	46	91	46
WEIGHT*	kg	10.9	10.9	10.9	10.9	11.4	11.4
	lbf	24.0	24.0	24.0	24.0	25.1	25.1
STROKE	mm	160	160	160	160	160	160
	in	6.3	6.3	6.3	6.3	6.3	6.3
BASE INERTIA	kg-cm <sup>2</sup>	5.5	5.5	5.5	5.5	6.5	6.5
	lb-in	1.9	1.9	1.9	1.9	2.2	2.2
MAX. SIDE LOAD (150 mm)	N	75		75			
	lbf	17		17			
AMBIENT TEMP ** RANGE	°C	0 to 50		0 to 50			
	°F	32 to 122		32 to 122			
IP RATING	Standard IP65 (static)						
AGENCY LISTINGS	 						

Table 2:  
CSW Weights

	Actuator Base Weight*	Add For Head Options			Round Rod Add For Stroke Length			Double D Rod Add For Stroke Length		
		Round Rod +94mm Head	Dbl-D +90mm Head	Dbl-D +94mm Head	200 mm (7.9 in)	250 mm (9.8 in)	300 mm (11.8)	200 mm (7.9 in)	250 mm (9.8 in)	300 mm (11.8)
kg	9.661	0.028	0.238	0.273	0.72	1.62	2.52	0.80	1.80	2.80
lb	21.3	0.06	0.52	0.6	1.59	3.57	5.56	1.76	3.97	6.17

\*3 Stack Motor, Round Rod, 90mm Head, RN05, 160mm Stroke

	Add For Screw Type	Add For Feedback Device					Add For Option			
	RN10	Kuka	ABB	Fanuc A1000/A128	Fanuc A64 Covered	Sick	4-Stack Motor	Brake	Water Cooling	Trunnion
kg	0.076	0.816	0.864	0.576	0.933	0.66	0.63	0.505	0.183	0.579
lb	0.17	1.8	1.91	1.27	2.06	1.46	1.39	1.11	0.4	1.28

### WEIGHT SUMMARY

Stroke	Weight		
		Min.	Max.
160 mm	kg	10.24	12.84
6.3 in	lb	22.57	28.31
200 mm	kg	10.96	13.64
7.9 in	lb	24.16	30.07

Stroke	Weight		
		Min.	Max.
250 mm	kg	11.86	14.64
9.8 in	lb	26.14	32.28
300 mm	kg	12.76	15.64
11.8 in	lb	28.12	34.48

## Motor Specifications:

MOTOR WINDING / MOTOR VOLTAGE		SERIES	CSW_			
			_V23	_V43	_V24	_V44
TORQUE CONSTANT ( $K_t$ )	N-m/A Peak		0.66	1.27	0.64	1.28
	<i>in-lb/A Peak</i>		<i>5.8</i>	<i>11.3</i>	<i>5.7</i>	<i>11.4</i>
VOLTAGE CONSTANT ( $K_e$ )		V/Krpm Peak	79.8	154	77.6	155.1
STALL TORQUE	Radiant Cooled	N-m	4.3	4.3	5.7	5.7
		<i>in-lb</i>	<i>38.1</i>	<i>38.1</i>	<i>50.1</i>	<i>50.1</i>
	Water Cooled	N-m	9.7	9.7	13.4	13.4
		<i>in-lb</i>	<i>86.1</i>	<i>86.1</i>	<i>118.1</i>	<i>118.1</i>
CONTINUOUS STALL CURRENT	Radiant Cooled	$A_{RMS}$	5.2	2.6	7.2	3.6
	Water Cooled	$A_{RMS}$	12.3	6.1	17.3	8.7
PEAK TORQUE		N-m	16.6	16.6	21.9	21.9
		<i>in-lb</i>	<i>146.8</i>	<i>146.8</i>	<i>194.1</i>	<i>194.1</i>
PEAK CURRENT		$A_{RMS}$	20.3	10.1	29.0	14.5
RESISTANCE		Ohms	2.07	8.28	1.14	4.56
INDUCTANCE		mH	3.80	15.00	2.24	9.82
BUS VOLTAGE		$V_{RMS}$	230	460	230	460
SPEED @ RATED V		RPM	4100	4200	4200	4200
NO. OF POLES			8	8	8	8

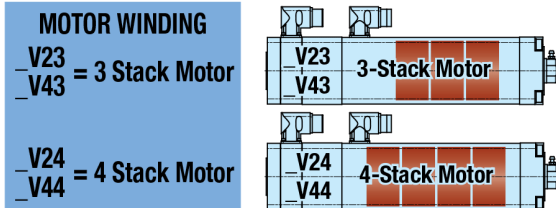

## Standard Thermal Switch Specifications

The motor windings have an integral normally closed thermal switch or resistance based temperature measurement device. These devices must be integrated with the robot controller. The switch opens at a temperature of 266° F (130°C), which is the windings maximum operating temperature. The thermal switch is meant to protect the windings, the actuators continuous operating region must still be obeyed. Operation that causes the windings temperature to approach 266° F (130° C) will reduce the expected life of the actuator.



### NOTE!

See Tolomatic Tolomatic CSW catalog #2750-4027 or [CSWX catalog #2750-4024](#) for complete and up-to-date specifications

## Appendix B: Troubleshooting Procedure

SYMPTOM	POTENTIAL CAUSE	SOLUTION
No response from actuator	Controller / Drive not enabled	Enable Controller/Drive
	Controller / Drive faulted	Reset the Controller/Drive
	Improper / Failed wiring	Check the wiring
Drive is enabled but actuator is not operating or is operating erratically	Improper robot motor file selected	Confirm motor file selection with robot manufacturer
	Improper ServoWeld / gun system calibration in robot controller	Confirm ServoWeld / gun system has been calibrated per robot manufacturer calibration procedure
	Feedback wiring may be incorrect	Verify feedback wiring
Actuator is operating but is not up to rated speeds/force	Improper robot motor file selected	Confirm motor file selection with robot manufacturer
	Improper ServoWeld / gun system calibration in robot controller	Confirm ServoWeld / gun system has been calibrated per robot manufacturer calibration procedure
	Motor phases are wired incorrectly or in incorrect order	Verify correct wiring of motor armature
	Drive may be improperly tuned	Check all gain settings
	Drive may be set up improperly for ServoWeld actuator used	Check drive settings for number of poles, voltage, current, resistance, inductance, inertia, etc.
	Feedback is improperly aligned	Contact Tolomatic
Actuator cannot move	Force is too large for the capacity of the actuator or too much friction is present	Verify force requirements
	Excessive side load	Verify correct operation
	Misalignment of output rod to application	Verify correct alignment
	Drive has too low of current capacity or is limited to tool low of current capacity	Verify correct drive and settings
	Actuator has crashed into hard stop	Disconnect from load and manually move away from hard stop. If problem persists, contact Tolomatic for service.
Actuator housing moves or vibrates when shaft is in motion	Loose mounting	Check actuator mounting
	Drive is improperly tuned – wrong gain settings	Tune drive
Actuator is overheating	Improper robot motor file selected	Confirm motor file selection with robot manufacturer
	Improper ServoWeld / gun system calibration in robot controller	Confirm ServoWeld / gun system has been calibrated per robot manufacturer calibration procedure
	Duty cycle is higher than actuator ratings	Verify duty cycle is within continuous ratings
	Drive is poorly tuned, causing excessive unnecessary current to be applied to motor	Check gain settings
	Actuator low or out of grease	Re-lubricate (if applicable)

<b>SYMPTOM</b>	<b>POTENTIAL CAUSE</b>	<b>SOLUTION</b>
Overheat fault - however actuator is not hot	Cable broken or connector disconnected	Replace faulty cable and/or insure proper connections

## ■ APPENDIX C: Warranty

### ■ C.1 Warranty

#### ■ Warranty and Limitation of Liability

Tolomatic's complete terms and conditions can be found here <https://www.tolomatic.com/info-center/resource-details/terms-and-conditions>

#### ■ Limited Warranty

Tolomatic warrants that at the time of delivery, Products shall be in good condition, free from defects in material and workmanship and that Products made to order shall conform to applicable drawings or specifications as referenced in the quotation or accepted purchase order ("Product Warranty"). The Product Warranty shall expire one year from date of shipment (the "Warranty Period"). Tolomatic warrants that Buyer shall acquire good title to the Products free from third party rights. These warranties are given only to Buyer and not to any third party.

The Product Warranty excludes any defects or non-conformance resulting (wholly or in part) from: (i) accidental damage, mishandling, incorrect installation, negligence or other circumstances arising after delivery; (ii) the repair or alteration of the Product by any party other than Tolomatic or its authorized representative; (iii) the failure by Buyer to provide a suitable storage, use, or operating environment for the Products; (iv) Buyer's use of the Products for a purpose or in a manner other than that for which they were designed; and (v) other abuse, misuse or neglect of the Products by Buyer or any third party.

The Product Warranty excludes any Products not manufactured by Tolomatic. Insofar as any Products are manufactured by third parties, Tolomatic shall, insofar as it can, pass to the Buyer the benefit of all warranties given by the supplier of such Products.

The Product Warranty shall be limited to defects of which Tolomatic is notified within twenty-one (21) days from the date of shipment to Buyer or, in the event of latent defects, within twenty-one (21) days of the defect being discovered and provided that such notice is received within the Warranty Period. As sole remedy for the breach of the warranty in paragraph (a) above, provided that (if required by Tolomatic) all non-conforming Products are returned to Tolomatic at Buyer's cost, and provided that Tolomatic confirms the defect or non-conformance, Tolomatic shall at its option (i) replace or repair the defective or non-conforming items, or correct any defective work or non-conformance, or (ii) refund to Buyer the original purchase price of the defective or non-conforming item and reimburse to Buyer any transportation and insurance charges incurred by Buyer.

Any claim by Buyer against Tolomatic alleging the breach of the Product Warranty must be commenced within twelve (12) months following the date of the alleged breach.

In the event the parties disagree whether or not a breach of the Product Warranty has occurred, Tolomatic may (but shall not be obliged to) undertake any repairs or replacement requested by Buyer pending final settlement of the matter. If it is determined that no such breach has occurred, Buyer shall pay Tolomatic upon demand the reasonable price of the repairs, corrections, or replacements made by Tolomatic including allowances for overheads and a reasonable profit margin.

THE WARRANTIES EXPRESSLY MADE UNDER THESE TERMS ARE EXCLUSIVE AND GIVEN IN LIEU OF ALL OTHER REPRESENTATIONS, WARRANTIES AND COVENANTS THAT MAY BE IMPLIED BY LAW, BY CUSTOM OF TRADE, BY THESE TERMS, BY THE PURCHASE ORDER OR OTHERWISE WITH RESPECT TO THE PRODUCTS. TO THE FULL EXTENT PERMITTED BY LAW, TOLOMATIC DISCLAIMS AND BUYER WAIVES ALL SUCH REPRESENTATIONS, WARRANTIES AND COVENANTS INCLUDING BUT NOT LIMITED TO, ANY IMPLIED WARRANTIES OF MERCHANTABILITY, FITNESS FOR A PARTICULAR PURPOSE OR NON-INFRINGEMENT OF THIRD PARTY INTELLECTUAL PROPERTY RIGHTS. BUYER'S SOLE REMEDY FOR BREACH OF WARRANTY IS STATED IN PARAGRAPH (d) ABOVE.

No Products shall be returned without Tolomatic's prior written consent. Products which Tolomatic consents to have returned shall be shipped by Buyer at Buyer's risk and expense, freight prepaid, to such location as Tolomatic designates.

## ■ Limitation of Liability

Tolomatic shall in no event be liable to Buyer or any third party, whether in contract, tort (including negligence), misrepresentation, strict liability or otherwise, for any incidental, punitive, consequential, indirect or special damages, including any loss of profits or savings or anticipated profits or savings, loss of data, loss of opportunity, loss of reputation, loss of goodwill or business or potential business, however caused, even if Tolomatic has been advised of the possibility of such damages in advance.

Under no circumstances shall Tolomatic's liability to Buyer in connection with any purchase order or Products supplied to Buyer exceed an amount equal to the amount paid by Buyer for such Products.

Buyer agrees and understands that it is solely Buyer's responsibility to ensure that Products are suitable for Buyer's requirements and for the environment, facilities or machinery for which they are intended by Buyer or by its end-customer to be fitted or used. Even if Tolomatic is advised of Buyer's intended use, Tolomatic makes no representation or warranty that the Product will be suitable for that purpose. Any technical advice furnished by Tolomatic relating to the intended use of the Products is given for information only and Tolomatic assumes no obligation or liability for the advice given or the results obtained. Except insofar as specifications or drawings form part of a purchase order and the Product Warranty, to the full extent permitted by law, Tolomatic disclaims and Buyer waives all representations, warranties and covenants that may be implied from the provision by Tolomatic of technical advice or information about Product. All such advice and information are accepted by Buyer at its risk.

Insofar as any liability or warranty of Tolomatic cannot be limited or excluded under applicable law, including any laws that do not permit limitations on liability relating to death or personal injury, the provisions of these terms and conditions shall be construed as being subject to such legal limitations, but only if those legal provisions have effect in relation to Tolomatic's liability notwithstanding the governing law provision in Section 18

## ■ Product Return Procedure

1. Before initiating the RMA process and obtaining an RMA number, please contact the Tolomatic Technical Support team to determine if it is possible to correct the issue in the field.
2. If an RMA is needed your Tolomatic Technical support team will initiate the RMA process and set up an RMA number.

### USA - Headquarters

#### Tolomatic Inc.

3800 County Road 116  
Hamel, MN 55340, USA

**Phone:** (763) 478-8000

Toll-Free: **1-800-328-2174**

sales@tolomatic.com

[www.tolomatic.com](http://www.tolomatic.com)

### MEXICO

#### Centro de Servicio

Parque Tecnológico Innovación

Int. 23, Lateral Estatal 431,

Santiago de Querétaro,

El Marqués, México, C.P. 76246

**Phone:** +1 (763) 478-8000

help@tolomatic.com

### EUROPE

#### Tolomatic Europe GmbH

Elisabethenstr. 20

65428 Rüsselsheim

Germany

**Phone:** +49 6142 17604-0

help@tolomatic.eu

### CHINA

#### Tolomatic Automation Products (Suzhou) Co. Ltd.

No. 60 Chuangye Street, Building 2

Huqiu District, SND Suzhou

Jiangsu 215011 - P.R. China

**Phone:** +86 (512) 6750-8506

ServoWeldChina@tolomatic.com

## Appendix D: Declaration of Conformity

CE	<b>Tolomatic</b> <sup>TM</sup> EXCELLENCE IN MOTION	CE
<b>EU Declaration of Conformity</b>		
No: 36004710_03		
We the manufacturer,		
<b>Tolomatic</b> <b>3800 County Road 116</b> <b>Hamel, MN 55340</b> <b>USA</b>		
declare under our sole responsibility that the product(s),		
<b><i>CSW and CSWX Actuators</i></b>		
<b><i>All Models</i></b>		
Fulfills the essential requirements of the following directives:		
<b>LVD Directive (2014/35/EU)</b> EN 60034-1:2010/AC:2010 Rotating electrical machines Part 1 Rating and performance		
<b>RoHS Directive (2011/65/EU, as amended by (EU) 2015/863)</b>		
<b>REACH (Regulation (EC) No 1907/2006)</b>		
Assumption of conformity is based on the application of the harmonized or applicable technical standards and, when applicable or required, a European community notified body certification.		
 _____ Brad Schulz Director of Engineering & Technology	28.10.2022 _____ Date of Issue (dd.mm.yyyy)	

© 2024 Tolomatic

Tolomatic. All rights reserved.

Tolomatic and Excellence In Motion are registered trademarks of Tolomatic Incorporated. All other products or brand names are trademarks of their respective holders. [www.tolomatic.com](http://www.tolomatic.com)



**Tolomatic**<sup>TM</sup>  
EXCELLENCE IN MOTION

COMPANY WITH  
QUALITY SYSTEM  
CERTIFIED BY DNV GL  
= ISO 9001 =  
Certified site: Hamel, MN

<b>USA - Headquarters</b> <b>Tolomatic Inc.</b> 3800 County Road 116 Hamel, MN 55340, USA <b>Phone:</b> (763) 478-8000 Toll-Free: <b>1-800-328-2174</b> sales@tolomatic.com <a href="http://www.tolomatic.com">www.tolomatic.com</a>	<b>MEXICO</b> <b>Centro de Servicio</b> Parque Tecnológico Innovación Int. 23, Lateral Estatal 431, Santiago de Querétaro, El Marqués, México, C.P. 76246 <b>Phone:</b> +1 (763) 478-8000 help@tolomatic.com	<b>EUROPE</b> <b>Tolomatic Europe GmbH</b> Elisabethenstr. 20 65428 Rüsselsheim Germany <b>Phone:</b> +49 6142 17604-0 help@tolomatic.eu	<b>CHINA</b> <b>Tolomatic Automation Products (Suzhou) Co. Ltd.</b> No. 60 Chuangye Street, Building 2 Huqiu District, SND Suzhou Jiangsu 215011 - P.R. China <b>Phone:</b> +86 (512) 6750-8506 ServoWeldChina@tolomatic.com
---	---	--	--

All brand and product names are trademarks or registered trademarks of their respective owners. Information in this document is believed accurate at time of printing. However, Tolomatic assumes no responsibility for its use or for any errors that may appear in this document. Tolomatic reserves the right to change the design or operation of the equipment described herein and any associated motion products without notice. Information in this document is subject to change without notice.

Visit [www.tolomatic.com](http://www.tolomatic.com) for the most up-to-date technical information